

**WILDMAGMA®**

C A T A L O G U E

2 0 2 2

# ABOUT US

Wild Magma's range of products aims at establishing a link between functionality and a distinctive appeal. Continued experience in delivering the best in class and quality products timely and efficiently makes Wild Magma a celebrated name in the global F&B industry.

Every creation represents an exceptional characteristic that attractively modifies the space. A contemporary conceptualization is reflected through the four elementary aesthetics representing modish glassware, trendy flatware, elegant accessories, and an inventive banquet collection.

The meticulous craftsmanship of local and global designers provides the essence of detailing and superior finish. At Wild Magma it's all about innovatively providing products that aren't time bound but are individually unique.

Thriving on consistency, exclusivity, and proficiency the brand boasts of being a reliable supplier to premium hotel chains across the world. Resolving the bewildering gap between the eternal and the eccentric, every masterpiece tells a tale of triumph.

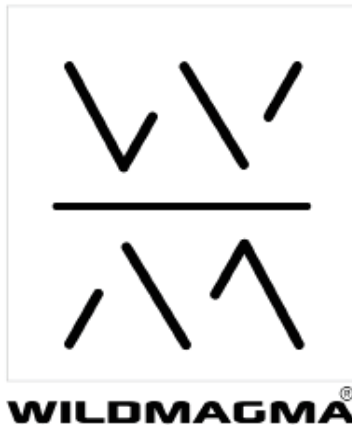

#### ADDRESS

Warehouse 19, Al Quoz Industrial Area 3, Off Sheikh Zayed  
Road, P.O. Box 283073, Dubai, UAE

#### INFO

Email Us: [info@wildmagma.com](mailto:info@wildmagma.com)  
[www.wildmagma.com](http://www.wildmagma.com)

## FIRE

Igniting the inner fire with temerity and temptation, the element of fire takes a detour from the conventional. The contemporary take on cooking stations exemplifies an easy to install, convenient to maintain, and endearing to the eyes layout. Making the banquet and buffet experience more holistic and seamless the fire products are made from all things tough and durable.



## WATER

'Ingenious' as they say, it's the modish designs that make the glassware range so enticing yet exclusive. Idolizing the many parameters of the aqua-inspired theme, every piece resonates the meticulous skills and superior finish to fulfil the main purpose- every drink demands a perfect glass!



## SPACE

Innovations are stemmed out of infinite possibilities. A universe is driven by curiosity and zeal to discover the unusual and in turn be amazed by the wonders.. This concept is a revolution when it comes to modern-day novelties. An exploration of parameters which have an edge above the others. It's the idea of bridging the gaps between futuristic inventions and availability



## AIR

An essence of antiquity and charisma is reflected through the masterpieces that aren't time bound but are individually unique. The splendour of breezy and antique styles is echoed through the airy collection of cutleries; classic, vintage, copper, gold, and black. Every piece outlines the surreal bond between an inventive design and a premium quality.



## EARTH

Primitive and innate; the earthly inspired concepts strike the balance between the exquisiteness of nature's flair with the conviction of sustainability. The timeless elegance of the ashtray collection to the minimalistic placemats to the sleek salt and pepper mills to the edgy wooden boards; the accessories have an untameable rawness in appeal and sophistication in attitude.



# CONTENTS



## 8 **Banquet & Equipment**

Enhancing the banquet and buffet experience with holistic products and a customized approach

## 91 **Flatware**

Cutting the conventional and delivering flatware in different finishes that complement the eating experience.

## 138 **NEW! Inroom Guest Supplies**

Give your rooms an upscale and prestigious look with leatherette in-room & high quality bathroom accessories



## 59 **Barware**

Wild Magma's range of essential Bar Tools will be the start of your successful bar operations

## 110 **Tabletop & Accessories**

Going that extra mile to blend functionality and creativity with products that are an outcome of novel ideas

## 168 **Our clients**

We take pride in our continuously growing customers around the world and the unique selection of products for the hospitality industry



## 70 **Glassware**

The many ranges in this collection explore the sophistication of serving a drink in appropriate glassware.

## 130 **NEW! Food & Beverage Menu**

Customize your menu design with Wild Magma, from high quality leatherette to wood, we produce bespoke Menu covers and more!



B A N Q U E T





Location: Burj Al Arab



## B U F F E T S T A T I O N S

Contemporary F&B industry drives on all things handy, modular, and multi-purpose. Wild Magma is inspired by the properties of Tetris and focuses on making the banquet and buffet experience flexible, mobile, and easy to deploy. The explicit range of products encompasses items that offer utmost flexibility of blending, customizing, and creatively using products for multiple occasions and requirements.

Foshan Gesign Maker's contribution to Wild Magma's cooking stations has revamped the experience of culinary preparations. Wild Magma proudly partners with Foshan to bring the latest innovations to the Middle East market.

# BUFFET STATION

## U-LINE

WM-GULBR-FRA01

1700 x 800 x 850 (H) mm







# BUFFET STATION | U-LINE



U-Line Stand Collection  
WM-GULB-FRA01

1700 x 800 x 850 (H) mm

Induction Cooking Station



- Full Folding and removable frame
- Metal material
- Brushed Stainless Steel or Metal with powder coating color)
- Removable high-power distributor with 4 interfaces (7000 W, with Aviation plug), with 1 pc wooden dish rack with Double faced Fire resistant laminate surface and SS edge, can hold 3 pcs Floating standard 1/3 size modules,

# HOT

## Buffet Variations



**Induction Cooking Station**  
1700 x 800 x 850 (H) mm



**Heating Plate Station**  
1700 x 800 x 850 (H) mm



**Induction Wok & Heating Plate Station**  
1700 x 800 x 850 (H) mm



**Peking Duck Station**  
1700 x 800 x 850 (H) mm



**Carving Station**  
1700 x 800 x 850 (H) mm



**Soup Station**  
1700 x 800 x 850 (H) mm



**Dim Sum Station**  
1700 x 800 x 850 (H) mm



**Induction & Griddle Station**  
1700 x 800 x 850 (H) mm



**Pasta Noodle Station**  
1700 x 800 x 850 (H) mm

# COLD

## Buffet Variations



**Ice Bin Station**  
1700 x 800 x 850 (H) mm



**Sushi & Sashimi Station**  
1700 x 800 x 850 (H) mm



**Flat Station with Plate Warmer**  
1700 x 800 x 850 (H) mm



# BUFFET STATION

H-LINE

WM-GHLB-FRA06

1700 x 800 x 850 (H) mm



12  
B A N Q U E T





# BUFFET STATION | H-LINE



H-Line Stand Collection  
WM-GHLB-FRA06  
1700 x 800 x 850 (H) mm  
Induction Cooking Station



- Full Folding and removable frame
- Metal material
- Brushed Stainless Steel or Metal with powder coating color
- Removable high-power distributor with 4 interfaces ( 7000W, with Aviation plug ), with 1 pc wooden dish rack with Double faced Fire resistant laminate surface and SS edge, can hold 3 pcs Floating standard 1/3 size modules,

# HOT

## Buffet Variations



**Induction Cooking Station**  
1700 x 800 x 850 (H) mm



**Heating Plate Station**  
1700 x 800 x 850 (H) mm



**Induction Wok & Heating Plate Station**  
1700 x 800 x 850 (H) mm



**Peking Duck Station**  
1700 x 800 x 850 (H) mm



**Carving Station**  
1700 x 800 x 850 (H) mm



**Soup Station**  
1700 x 800 x 850 (H) mm



**Dim Sum Station**  
1700 x 800 x 850 (H) mm



**Induction & Griddle Station**  
1700 x 800 x 850 (H) mm



**Pasta Noodle Station**  
1700 x 800 x 850 (H) mm

# COLD

## Buffet Variations



**Ice Bin Station**  
1700 x 800 x 850 (H) mm



**Sushi & Sashimi Station**  
1700 x 800 x 850 (H) mm



**Flat Station with Plate Warmer**  
1700 x 800 x 850 (H) mm

# BUFFET STATION | X-LINE

WM-GXLB-FRA05

1700 x 800 x 850 (H) mm

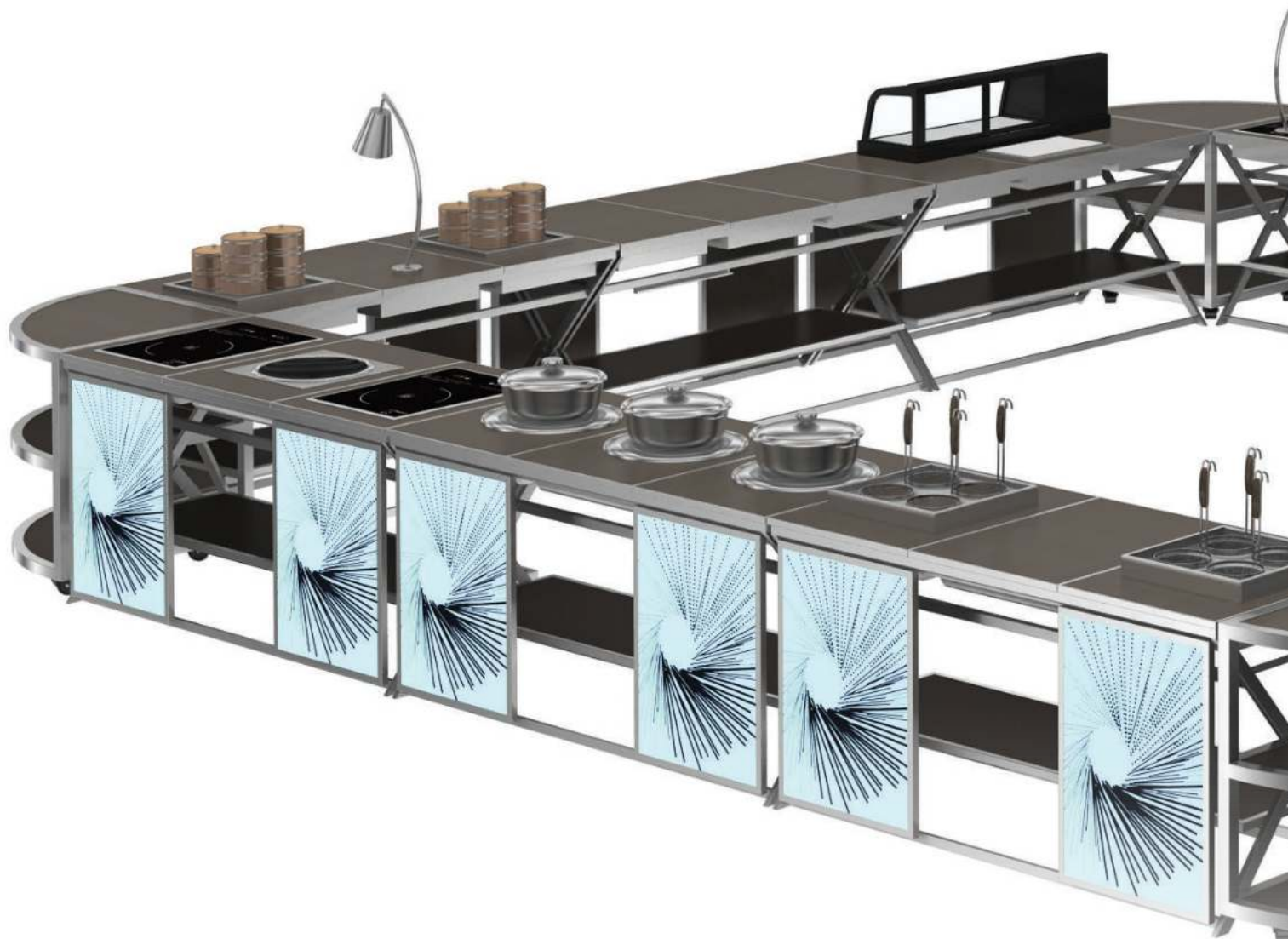





# BUFFET STATION | X-LINE



X-Line Stand Collection  
WM-GXLB-FRA05  
1700 x 800 x 850 (H) mm

## Induction Cooking Station



- Full Folding and removable frame
- Metal material
- Brushed Stainless Steel or Metal with powder coating color
- Removable high-power distributor with 4 interfaces ( 7000W, with Aviation plug ), with 1 pc wooden dish rack with Double faced Fire resistant laminate surface and SS edge, can hold 3 pcs Floating standard 1/3 size modules,

# HOT

## Buffet Variations



**Induction Cooking Station**  
1700 x 800 x 850 (H) mm



**Heating Plate Station**  
1700 x 800 x 850 (H) mm



**Induction Wok & Heating Plate Station**  
1700 x 800 x 850 (H) mm



**Peking Duck Station**  
1700 x 800 x 850 (H) mm



**Carving Station**  
1700 x 800 x 850 (H) mm



**Soup Station**  
1700 x 800 x 850 (H) mm



**Dim Sum Station**  
1700 x 800 x 850 (H) mm



**Induction & Griddle Station**  
1700 x 800 x 850 (H) mm



**Pasta Noodle Station**  
1700 x 800 x 850 (H) mm

# COLD



**Ice Bin Station**  
1700 x 800 x 850 (H) mm



**Sushi & Sashimi Station**  
1700 x 800 x 850 (H) mm



**Flat Station with Plate Warmer**  
1700 x 800 x 850 (H) mm



T H E E S S E N T I A L S

Wild Magma's comprehensive range of products includes, but isn't limited to buffet stations, banquet tables, conference tables, cocktail tables, chairs, service trolleys, mobile bars, dance floor, and stage.



# EASY SET UP

## Buffet Stations

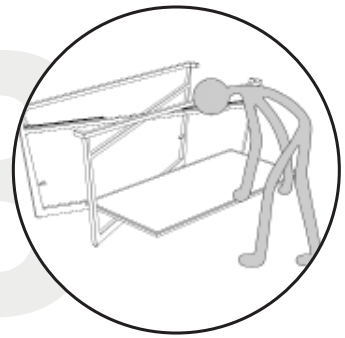
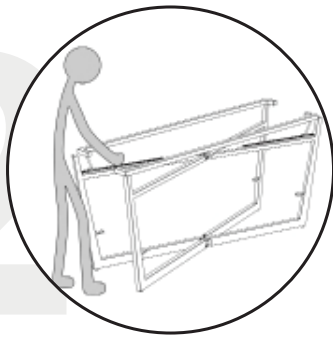
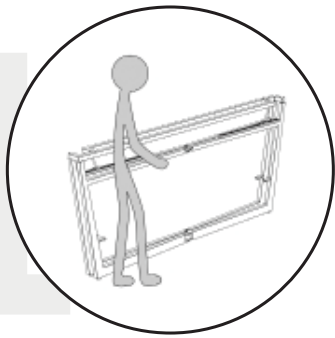

# THE ESSENTIALS

## MODULES



**Wooden Flat Table Top (1/3)**

**WM-GEA-1/3WOFT01M**

565 x 800 x 20 (H) mm

High strength composite water proof plywood, Double faced Fire resistant laminate surface, seamless aviation aluminum alloy edge



**Wooden Flat Table Top (2/3)**

**WM-GEA-2/3WOFT02M**

1130 x 800 x 20 (H) mm

High strength composite water proof plywood, Double faced Fire resistant laminate surface, seamless aviation aluminum alloy edge



**Wooden Flat Table Top (3/1)**

**WM-GEA-3/1WOFT03M**

1695 x 800 x 20 (H) mm

High strength composite water proof plywood, Double faced Fire resistant laminate surface, seamless aviation aluminum alloy edge



**Flat Module with Condiment Holder (1/3)**

**WM-GEA-FCH04M**

565 x 800 x 130 (H) mm

High strength composite water proof plywood, Double faced Fire resistant laminate surface, seamless aviation aluminum alloy edge, metal protective bottom cover. 4 compartments condiment holder-PC cooling pat/ice space bottom



**Induction Cooking Module (1/3)**

**WM-GEA-IND05M**

565 x 800 x 200 (H) mm

High strength composite plywood with Double faced Fire resistant laminate surface, seamless aviation aluminum alloy edge, hidden power wire design, metal protective bottom cover. 1 built-in induction, 220V-2000W



**Induction Cooking Module with Condiment Holder (1/3)**

**WM-GEA-INDCH06M**

565 x 800 x 130 (H) mm

High strength composite plywood, Double faced Fire resistant laminate surface, seamless aviation aluminum alloy edge, metal protective bottom cover. 1 built-in cooking induction, 4 compartments condiment holder-PC with cooling pat/ice space bottom, 220V-2000W



**Full plate Double Head Induction Module (1/3)**

**WM-GEA-FPDH07M**

565 x 800 x 130 (H) mm

1 built-in double heating(warm and cooking) unit induction, Stainless Steel Edge, 220V 800W+2000W

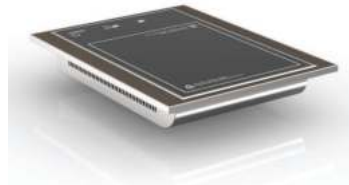

**Heating Plate Module (1/3)**

**WM-GEA-HP08M**

565 x 800 x 130 (H) mm

High strength composite plywood, Double faced Fire resistant laminate surface, seamless aviation aluminum alloy edge, hidden power wire design, metal protective bottom cover. 1 set built-in heating board(60-150°C), 220V 1500W

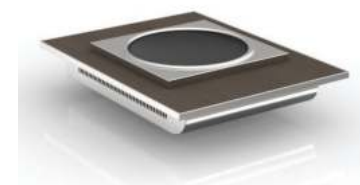

**Induction Wok Module (1/3)**

**WM-GEA-INDW09M**

565 x 800 x 330 (H) mm

High strength composite plywood, Double faced Fire resistant laminate surface, seamless aviation aluminum alloy edge, metal protective bottom cover. 1 built-in induction wok, 220V-3500W



**Pasta & Noodle Cooking  
Module (1/3)**

**WM-GEA-PAN10M**

565 x 800 x 130 (H) mm

High strength composite plywood, Double faced Fire resistant laminate surface, seamless aviation aluminum alloy edge, hidden power wire design, metal protective bottom cover. 1 set 4 holes noodle cooking stove, drainage system, 220V-3000W



**Dim Sum Module (1/3)**

**WM-GEA-DIM11M**

565 x 800 x 140 (H) mm

High strength composite plywood, Double faced Fire resistant laminate surface, seamless aviation aluminum alloy edge, hidden power wire design, metal protective bottom cover. 1 set Dim sum stove, drainage system, 220V-3000W



**Soup Warmer Module (1/3)**

**WM-GEA-SOU12M**

565 x 800 x 140 (H) mm

High strength composite plywood, Double faced Fire resistant laminate surface, seamless aviation aluminum alloy edge, metal protective bottom cover. 1 built-in stainless steel soup warmer & bucket, 220V-300W



**Deep Fryer Module (1/3)**

**WM-GEA-DEE13M**

565 x 800 x 530 (H) mm

High strength composite plywood, Double faced Fire resistant laminate surface, seamless aviation aluminum alloy edge, metal protective bottom cover. 1 built-in 5.5L deep fryer, 1 pc tempered glass panel, 220V-2800W

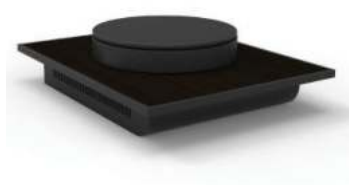

**Pancake Module (1/3)**

**WM-GEA-PN14M**

565 x 800 x 330 (H) mm

High strength composite plywood, Double faced Fire resistant laminate surface, seamless aviation aluminum alloy edge, metal protective bottom cover. 1 built-in Pancake stove, 220V-3000W



**Saj Module (1/3)**

**WM-GEA-SJ15M**

565 x 740 x 130 (H)mm

Color Black; Crepe Makers, Non Stick Spherical Cooking Surface, Input Voltage, 1800W



**Griddle Module**

**Small WM-GEA-SMA16M (1/3)**

**Large WM-GEA-LAR17M (2/3)**

(S) 565 x 800 x 130 (H) mm

(L) 1130 x 800 x 130 (H) mm

High strength composite plywood, Double faced Fire resistant laminate surface, seamless aviation aluminum alloy edge, hidden power wire design, metal protective bottom cover. 1 built-in griddle stove, 1 pc tempered glass panel, 220V-4000W



**Small Carving Module (1/3)**

**WM-GEA-SMAC18M**

565 x 800 x 130 (H) mm

High strength composite plywood, Double faced Fire resistant laminate surface, seamless aviation aluminum alloy edge, hidden power wire design, metal protective bottom cover. 1 built-in carving board, bottom Isothermal heating, 2 heating lamps, 220V-800W



**Large Carving Module (2/3)**

**WM-GEA-LARC19M**

1130 x 740 x 140 (H) mm

High strength composite plywood, Double faced Fire resistant laminate surface, seamless aviation aluminum alloy edge, hidden power wire design, metal protective bottom cover. 1 built-in carving board, bottom Isothermal heating, 2 heating lamps, 220V-800W

# THE ESSENTIALS

## MODULES

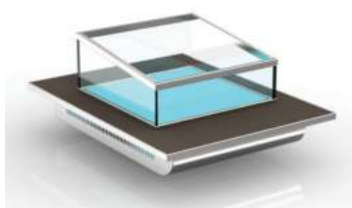

**Ice Bin Module**

**WM-GEA-SMAIB20M**

(S) 565 x 800 x 330 (H) mm (1/3)

**WM-GEA-LARIB22MA**

(L) 1130 x 800 x 330 (H) mm (2/3)

**WM-GEA-XLIB22MB**

(XL) 1695 x 800 x 330 (H) mm (3/1)

High strength composite plywood, Double-faced Fire resistant laminate surface, seamless aviation aluminium alloy edge, hidden power wire design, metal protective bottom cover. 1 built-in glass ice bin, SS protective edge, LED lighting system - remote control, drainage system, 220V-100W

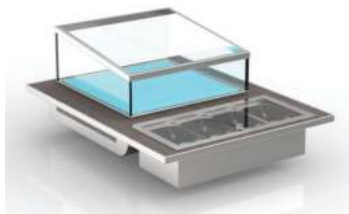

**Ice Bin Module with Condiment Holder (1/3)**

**WM-GEA-ICECH21M**

565 x 800 x 330 (H) mm

High strength composite plywood with Double faced Fire resistant laminate surface and seamless aviation aluminum alloy edge, metal protective bottom cover. 1 built-in glass ice bin, SS protective edge, LED lighting system - remote control, drainage system, 4 compartments condiment holder-PC, cooling pat or ice space bottom



**Hot & Cold Plate Module (1/3)**

**WM-GEA-CAHP23M**

565 x 800 x 230 (H) mm

High strength composite plywood, Double faced Fire resistant laminate surface, seamless aviation aluminum alloy edge, hidden power wire design, metal protective bottom cover. 1 built-in imported cold/hot all-in-one induction module, -5°C to 140°C of temperature range, 220V-1000W

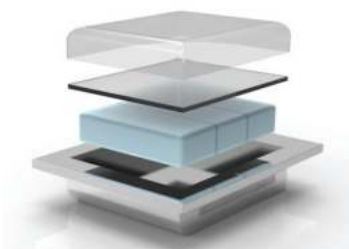

**Dessert Module (1/3)**

**WM-GEA-DES24M**

565 x 800 x 140 (H) mm

High strength composite plywood, Double faced Fire resistant laminate surface, seamless aviation aluminum alloy edge, metal protective bottom cover. 1 built-in stainless steel tank, 1 ice box inside with glass board & acrylic cover.



**Peking Duck Module (1/3)**

**WM-GEA-PEK26M**

565 x 800 x 1230 (H) mm

High strength composite plywood, Double faced Fire resistant laminate surface, seamless aviation aluminum alloy edge, metal protective bottom cover. 1 built-in stainless steel BBQ hanger, 2 pcs LED spot light, 1 set cutting board. 220V-500W



**Sushi Freezer Module**

**WM-GEA-SUFS27M**

(S) 1177x 420 x 295 (H)mm

**WM-GEA-SUFL28M**

(L) 1529 x 420 x 295 (H) mm

Single layer, 1.2M, 42L (varies), metal frame, back sliding door, front arc integrated glass automatic frost, automatic condensation water collection, internal LED lamp, electronic temperature control, temperature display 2-10°C, 220V 200W



**Heating Lamp Module**

**WM-GEA-HEATL25AM**

(Dia) 160 x 720 (H) mm

Brushed Stainless Steel  
220V, 150W



**Heating Lamp**

**WM-GEA-HEATL25B**

(Dia) 150 x 720 (H) mm

Brushed Stainless Steel  
220V, 150W



**Heating Lamp**

**WM-GEA-HEATL25C**

(Dia) 150 x 720 (H) mm

Brushed Stainless Steel  
220V, 150W



# THE ESSENTIALS

## ACCESSORIES

### PANEL COMBINATIONS

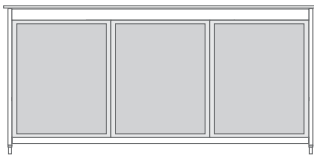

3 Front Panel (1/3)

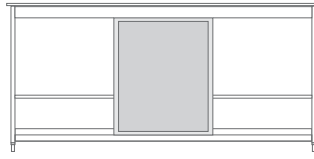

1 Front Panel (1/3)

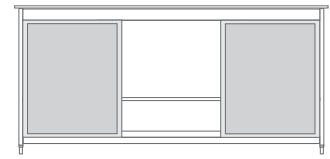

2 Front Panel (1/3)

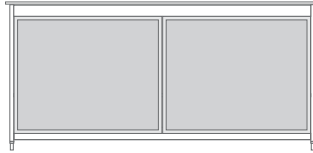

2 Front Panel (1/2)

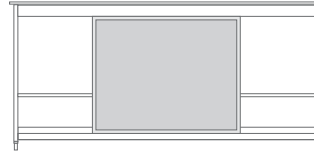

1 Front Panel (1/2)



Acrylic Front Panel (1/3)

**WM-GEA-FPACR01**  
535 x 715 x 10 mm

\*Size varies as per the station

Print customized pattern acrylic panel with SS edge

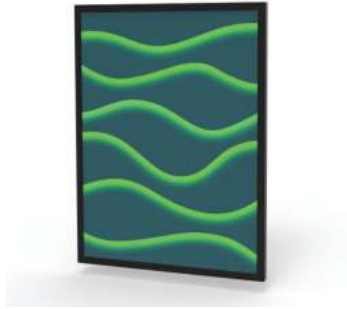

LED Front Panel (1/3)

**WM-GEA-1/3FP02**  
585 x 755 x 25 mm

\*Size varies as per the station

SS edge, customized printing pattern acrylic board, remote control 7 colors LED lighting system, 12V rechargeable Li battery.



LED Front Panel with laser cutting S/S pattern (1/3)

**WM-GEA-1/3FPL03**  
535 x 715 x 23 mm

\*Size varies as per the station

Customized laser cutting pattern S/S board, remote control 7 colors LED lighting system, 12V rechargeable Li battery.



Front Panel LCD with S/S Edge (1/3)

**WM-GEA-1/3FPS04**  
535 x 715 x 50 mm

\*Size varies as per the station

1/3 LCD Screen front Panel with S/S edge  
Steel edge with black powder coating, built-in 29" LCD screen, USB port & Wifi.



Front Panel with laser cutting S/S pattern (1/3)

**WM-GEA-1/3FPL05**  
535 x 715 x 23 mm

\*Size varies as per the station

1/3 Front Panel Laser cutting S/S Pattern SS edge, customized laser cutting S/S board



Acrylic Front Panel (1/2)

**WM-GEA-1/2FPACR06**  
802.5 x 715 x 23 mm

\*Size varies as per the station

Print customized pattern acrylic with SS edge

# THE ESSENTIALS

## ACCESSORIES

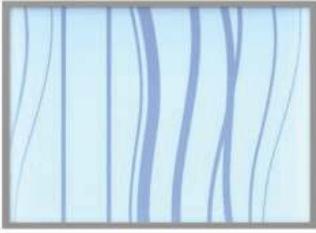

**LED Front Panel (1/2)**

**WM-GEA-1/2FP07**

802.5 x 715 x 23 mm

\*Size varies as per the station

SS edge, customized printing pattern acrylic board, remote control 7 colors LED lighting system, 12V rechargeable Li battery.

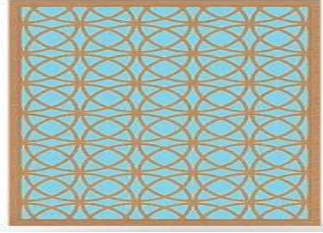

**Front Panel LED with laser cutting S/S pattern (1/2)**

**WM-GEA-1/2FPL08**

802.5 x 715 x 23 mm

\*Size varies as per the station

1/2 LED front Panel with laser cutting S/S pattern  
SS edge, customized laser cutting pattern S/S board, remote control 7 colors LED lighting system, 12V rechargeable Li battery.



**Front Panel with laser cutting S/S pattern (1/2)**

**WM-GEA-1/2FPLS09**

802.5 x 715 x 23 mm

\*Size varies as per the station

SS edge, customized laser cutting pattern S/S board

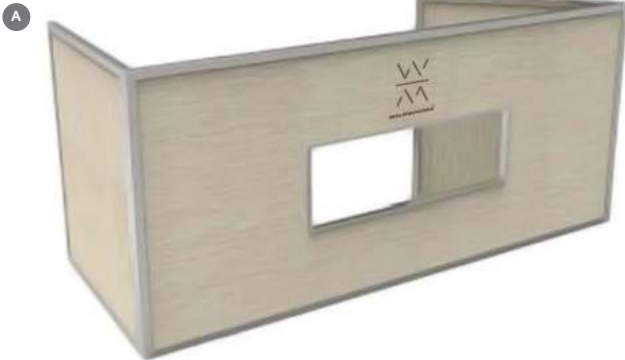

**Full Folding Panel**

**A: WM-GEA-FFPA1**

**B: WM-GEA-FFPB1**

**C: WM-GEA-FFPC1**

1725 x 800 x 925 (H) mm

\*Size varies as per the station



# THE ESSENTIALS

## ACCESSORIES



Round Side Station (1/4)  
**WM-GEA-1/4RSSW**  
 800 x 800 x 850 mm



Round Side Station (1/4)  
**WM-GEA-1/4RSSG**  
 800 x 800 x 850 mm



Round Side Station  
 with Plate Warmer  
**WM-GEA-RSSPW**  
 800 x 800 x 850 mm



Plate Warmer Trolley  
**WM-GOA-PLAT02**  
 450 x 450 x 850 (H) mm  
 plating stainless steel frame and panel  
 with rosegold palting,quarzt table  
 top,single plate warmer hole.



Plate Warmer Trolley  
**WM-GOA-PLAT04**  
 950 x 530 x 1030 (H) mm  
 Wooden panel with stainless steel  
 decorating decorative line, quartz stone  
 top; double plate warmer holes.



Folding Platfond  
**WM-GEA-RFP**



Folding Platfond with LED  
**WM-GEA-LFP**

# THE ESSENTIALS

## LAMINATE & METAL FINISHING

### HPL LAMINATE OPTIONS OF MODULE TOP



**WM8909ST**



**WM4982ST**



**WM4983ST**



**WMA8084**



**WMA8085**



**WMA8086**



**WMA8121**



**WMA8123**



**WMA8131**



**WMA8133**



**WMA8139**



**WMA8135**

### 304# BRUSHED STAINLESS STEEL FRAME COLOR OPTIONS



**WMSS14**

Hairline S/S with  
Brown Plating



**WMSS12**

Hairline S/S with  
Gold Plating



**WMSS04**

Hairline S/S with  
Black Plating



**WMSS03**

Hairline S/S with  
Rose Gold Plating



**WMSS02**

Hairline S/S

### ALUMINIUM & STEEL FRAME COLOR OPTIONS (POWDER COATING FINISHING)



**WMPC-031**

Silver



**WMPC-036**

Red Gold



**WMPC-038**

Gold



**WMPC-053**

Brown & Gold



**WMPC-058**

Black



# THE ESSENTIALS

## MODULAR TROLLEY



### Module Trolley

**WM-GS-MODT01**

915 x 1200 x 1900 (H) mm

Steel frame with black powder coating finishing, black carpet surface, imported wheels;  
Configuration: safe bandage, anti-bumper device, each trolley can carry 6 pcs 2/3 modules  
or 12 pcs 1/3 modules, with dust cover.



### LED Panel Trolley

**WM-GS-LEDT02**

650 x 800 x 1950 (H) mm

Steel frame with black powder coating finishing, carpet surface. 12 pcs LED panels  
capacity, with charging socket, with dust cover.



### Buffet Stand Trolley

**WM-GS-BUFST03**

1965 X 900 X 1770 (H) mm

Steel frame with black powder coating finishing, black carpet surface, imported wheels;  
Configuration: safe bandage, anti-bumper device, each trolley can hold 10 sets tables, with  
dust cover.



T r o l l e y s   a n d   m o r e

Room Service is more important than ever, providing guests with service of Food & Beverage in privacy. The explicit range of trolleys, banquet tables, conference tables and mobile bars encompasses items that offer utmost flexibility of blending, customizing, and creatively using products for multiple occasions and requirements.

# THE ESSENTIALS

## MODULAR TROLLEY

Wild Magma's modular trolley is well-equipped to be individually used or be paired with a module as per the requirement. High functionality and supreme design make it a viable option for many.



### C Line Modular Trolley with Ice bin

**WM-GESE-MTIB01**

Table: 565 x 800 x 920 (H) mm

Ice bin: 565 x 800 x 108 (H) mm

304 brushed stainless steel frame with rose gold plating finishing, 3 sides laminate surface panel, built-in 1 pc 32" LCD TV screen side panel on side. Hidden power wire and socket design, anti-bumper rim and heavy duty wheels.

**Configuration:** 1 pc removable Ice bin Module  
220V-200W



### C Line Modular Trolley-Rose Gold

**WM-GESE-CMRG02**

565 x 800 x 920 (H) mm

Flat Module Included- Interchangeable with any 1/3 modules

# THE ESSENTIALS

## BESPOKE MOBILE BAR

Wild Magma specialize in the supply of handmade mobile bars for any private or corporate event. They are fully customizable, brandable, versatile and can suit any space, creating the most elegant ambiance in private as well as for groups. Private and memorable experience with professional barware supply inclusive.



Fully Open Mobile Bar  
  
1512 x 658 x 1144 (H) mm



Close Mobile Bar  
1010 x 500 x 1144 (H) mm  
Customizable with LCD TV at the back option



# THE ESSENTIALS

## COLOUR/TEXTURE & METAL FINISHING

HPL LAMINATE OPTIONS OF MODULE TOP



PVC-110



PVC-111



PVC-114



PVC-120



PVC-123



PVC-134



PVC-137



PVC-156



PVC-219



PVC-221



PVC-233



PVC-265

304# BRUSHED STAINLESS STEEL FRAME COLOR OPTIONS



WMSS14

Hairline S/S with Brown Plating



WMSS12

Hairline S/S with Gold Plating



WMSS04

Hairline S/S with Black Plating



WMSS03

Hairline S/S with Rose Gold Plating



WMSS02

Hairline S/S

# MOBILE BARS

## FOLDABLE MOBILE BAR



WM-GE-MBF01



The bar consists of 3 modules:  
1 sink module,1 flat module,  
1 flat module with garbage hole,2 x removable speed rail



1800\*800\*1150 (H) mm



rosegold frame ,HPL wall and front panel,  
with laser cutting Acrylic customized logo,LED table top,pull out  
shelf board,H line folding frame,

# MOBILE BARS

## FOLDABLE MOBILE BAR



2000 x 900 x 1150(H)mm



Metal frame. solid wood panels, quartz stone bar table. high strength fireproof board operation table top; a detachable structure. very convenient for installation and storage. saving storage space; LED panel can be replaced pattern.

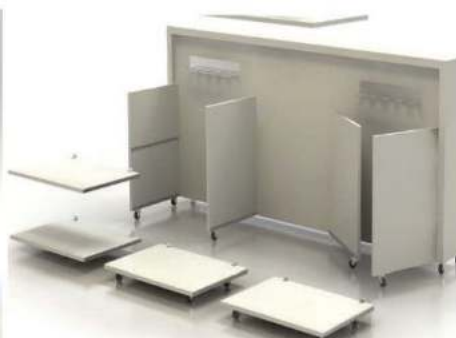

# MOBILE BARS



## WM-GE-MBCO4

wooden laminate finish  
black countertop  
brushed stainless steel

1800 x 800 x 900/1150 (H) mm



## WM-GE-MBCO5

wooden laminate finish  
detachable structure  
brushed stainless steel

1800 x 800 x 900/1150 (H) mm





**WM-GE-MBCO3**

customizable finishes available  
brushed stainless steel

1800 x 800 x 900/1150 (H) mm



**WM-GE-MBCO1**

config-sink, garbage bin,  
2x detachable speed rail,  
optional ss drip tray, LED border



1800 x 800 x 900/1150 (H) mm



**WM-GE-MBCO2**

marble finish  
customizable



1800 x 800 x 900/1150 (H) mm

# TROLLEYS

## SERVICE TROLLEY



**BRONZE SERVICE TROLLEY**   
**WM-GE-TS21S** 500\*800\*1000(H)mm



**SERVICE TROLLEY**   
**WM-GE-TS21S** 500\*800\*1000(H)mm



**SERVICE TROLLEY**   
**WM-GE-BTX01** 1060\*550\*850(H)mm



**SERVICE TROLLEY**   
**WM-GE-BTE03** 1060\*550\*850(H)mm



**SERVICE TROLLEY**   
**WM-GE-TT06S** 1060\*550\*850(H)mm

W I L D M A G M A C A T A L O G U E

W I L D M A G M A C A T A L O G U E

# TROLLEYS

## SERVICE TROLLEY



WM GEBTT06



Carving Trolley



Pasta Trolley



Service Trolley



Induction Trolley



Dim Sum Trolley



Cake Trolley



customized



**Jewellery Mobile Trolley**  
with ice gel cabinets & side drawers

1060 x 550 x 850 (H) mm



**Jewellery Mobile Trolley**  
with ice gel cabinets

1060 x 550 x 850 (H) mm



# TROLLEYS

## SERVICE TROLLEY



SERVICE TROLLEY  
WM-GE-MTS01

1. Sliding extended countertop;
2. Hidden removable modular of cooking and heating or cold food display function;
3. Very easy to setup or to remove
4. Modular combination design realizes multi-purpose

2 import universal wheels, 2 retro wheel!  
high polymer stone art facing top  
brushed stainless steel frame



# TROLLEYS

## ROOM SERVICE TROLLEY

### 5 FOLD TROLLEY

WM-DE-RST5F01  
1080 x 915 x 750 mm



**FOOD WARMER BOX STAND**  
WM-DE-RSTFWB01  
1605 X 450 X 1810 MM

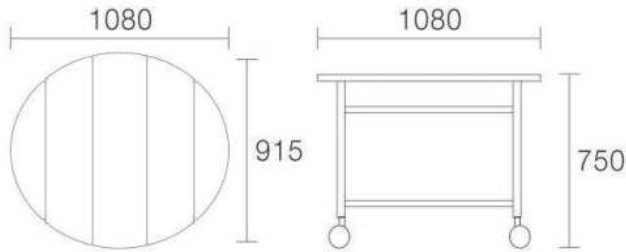

### 3 FOLD TROLLEY

WM-DE-RST3F02  
1050 x 900 x 760 mm



**FOOD WARMER BOX STAND**  
WM-DE-RSTFWB02  
870 X 440 X 1660 MM

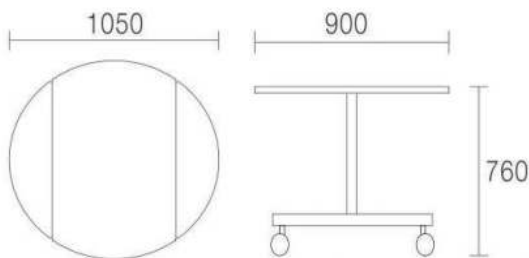

**FOOD WARMER**  
WM-DE-RSTFWW  
380 x 370 x 480 mm



# TROLLEYS

## CLEARANCE TROLLEY



**Clearance Trolley**  
**GE-BT62S**

1000\*1000\*450mm

- sliding top drawer
- Swing door with single shelf
- Wooden Laminate Finish



**Clearance Trolley**  
**GE-BT52S**

900\*1000\*500mm

- 2 cutlery drawer plus 2 small drawer for napkin
- sliding top drawer
- 2 Swing door. 1 with single shelf other for garbage bin
- Wooden Laminate Finish -



**Clearance Trolley**

1000\*1000\*450mm



# NESTING TABLES



all sets same sizes



700\*1100\*750 mm  
700\*1300\*900 mm  
700\*1500\*1050 mm





# NESTING TABLES



**Nesting Tables 4 pieces**  
**WM-GESE-CM01**

1960\*800\*920mm  
1800\*800\*840mm  
800\*800\*180mm

height adjustable  
Table Medium plain



Adjustable table with flat top module  
Frame : Stainless steel, Gilded, adjustable, removable with casters  
Table top : Glass or Plain HPL  
height adjustable



**Induction table**  
**WM-GESE-CM02**

SS edge, gilded, HPL top face  
1 x inductor 220V 1000W/PC  
Size : 800\*800\*180MM



**Cooling table**  
**WM-GESE-CM03**

SS edge, gilded frame, HPL top face  
1 x acrylic ice bin with blue color  
Size : 800\*800\*180MM



1960\*800\*920mm

# THE ESSENTIALS

## COCKTAIL TABLE

### COCKTAIL TABLE WITH FOLDING TOP



### REMOVABLE TABLE TOP, FOLDING TABLE



### FIXED TABLE TOP & STAND



### COCKTAIL TABLE WITH FOLDING TOP OPTIONS

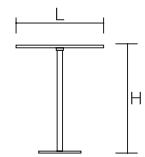
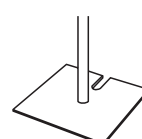
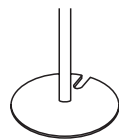

ITEM

SHAPES

A1 - ROUND BASE

A2 - SQUARE BASE

L W H



B1 - Laminate Table Top



B2 - Glass Table Top



B3 - LED Table Top

C1 - ROUND TABLE TOP

C2 - SQUARE TABLE TOP

C1 - ROUND TABLE TOP

C2 - SQUARE TABLE TOP

C1 - ROUND TABLE TOP

C2 - SQUARE TABLE TOP

**WM-DE-CTRL-RB01**

**WM-DE-CTSL-RB02**

**WM-DE-CTRG-RB03**

**WM-DE-CTSG-RB04**

**WM-DE-CTLEDR-RB05**

**WM-DE-CTLEDS-RB06**

**WM-DE-CTRL-SB01**

**WM-DE-CTSL-SB02**

**WM-DE-CTRG-SB03**

**WM-DE-CTSG-SB04**

**WM-DE-CTLEDR-SB05**

**WM-DE-CTLEDS-SB06**

600 x 600 x 1055 mm

600 x 600 x 1055 mm

600 x 600 x 1055 mm

600 x 600 x 1055 mm

600 x 600 x 1055 mm

600 x 600 x 1055 mm

# THE ESSENTIALS

## BANQUET & CONFERENCE CHAIR

### STAINLESS STEEL CHAIR

ITEM	CODE	SIZE		
		L	W	H
	WM-GE-BCSS-CH01	480	600	900

	WM-RE-BCSS-CH02	600	565	970
---	-----------------	-----	-----	-----

	WM-RE-BCSS-CH03	600	610	1000
--	-----------------	-----	-----	------

	WM-GE-BCSS-CH04	460	570	840
---	-----------------	-----	-----	-----

	WM-GE-BCSS-CH05	460	570	860
---	-----------------	-----	-----	-----

	WM-GE-BCSS-CH06	460	570	860
---	-----------------	-----	-----	-----

### STAINLESS STEEL CHAIR

ITEM	CODE	SIZE		
		L	W	H
	WM-GE-BCSS-CH07	460	580	840

	WM-GE-BCSS-CH08	460	580	840
---	-----------------	-----	-----	-----

	WM-GE-BCSS-CH09	465	570	880
--	-----------------	-----	-----	-----

	WM-GE-BCSS-CH10	460	580	840
---	-----------------	-----	-----	-----

	WM-GE-BCSS-CH11	460	570	960
---	-----------------	-----	-----	-----

### FLEX BACK STEEL CHAIR

ITEM	CODE	SIZE		
		L	W	H
	WM-RE-BCFB-CH12	485	600	880

# THE ESSENTIALS

## BANQUET & CONFERENCE CHAIR

### FLEX BACK STEEL CHAIR

ITEM	CODE	SIZE		
		L	W	H
	<b>WM-RE-BCFB-CH13</b>	460	535	940

	<b>WM-RE-BCFB-CH14</b>	460	535	930
---	------------------------	-----	-----	-----

	<b>WM-RE-BCFB-CH15</b>	460	570	840
--	------------------------	-----	-----	-----

### ALUMINUM CHAIR

ITEM	CODE	SIZE		
		L	W	H
	<b>WM-RE-BCAL-CH16</b>	460	580	925

	<b>WM-RE-BCAL-CH17</b>	390	440	920
---	------------------------	-----	-----	-----

### ALUMINUM CHAIR

ITEM	CODE	SIZE		
		L	W	H
	<b>WM-GE-BCAL-CH18</b>	460	630	920

	<b>WM-GE-BCAL-CH19</b>	460	590	950
--	------------------------	-----	-----	-----

	<b>WM-GE-BCAL-CH20</b>	480	620	925
--	------------------------	-----	-----	-----

	<b>WM-GE-BCAL-CH21</b>	490	600	960
---	------------------------	-----	-----	-----

	<b>WM-GE-BCAL-CH22</b>	470	600	880
--	------------------------	-----	-----	-----

	<b>WM-GE-BCAL-CH23</b>	460	560	920
--	------------------------	-----	-----	-----



# THE ESSENTIALS

## PARTITIONS



Wooden Partition with bronze corners  
(4 Folds)

**WM-GEA-PWS03**  
500x2000mm



Wooden Partition (4 Folds)

**WM-GEA-PWS02**  
600 x 2000 x 30 mm \*4



Arc-Shaped Partition (4 Folds)

**WM-GEA-PASS03**  
600 x 2000 x 30 mm \*4



Chinese Style HOLLOWED Partition (4 Folds)

**WM-GEA-PCS01**  
600 x 2000 x 30 mm \*4



Square and Round Partition (4 Folds)

**WM-GEA-PSRS04**  
600 x 2000 x 30mm \*4

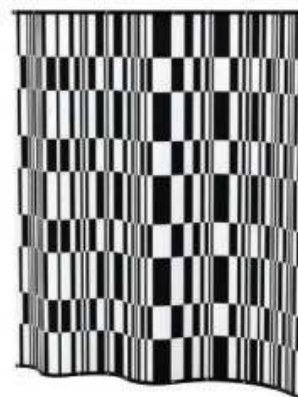

Freedom Partition (4 Folds)

**WM-GEA-PFS05**  
2400 x 2000 (H) mm



LED Partition Aqua (4 Folds)

**WM-GEA-PLEDA07**  
600 x 2000 (H) mm



LED Partition Gold (4 Folds)

**WM-GEA-PLEDG08**  
600 x 2000 (H) mm

# THE ESSENTIALS

## PODIUM



# THE ESSENTIALS

## PODIUM



**WM-GE-MR21S**  
550 x 500 x 1200 (H) mm

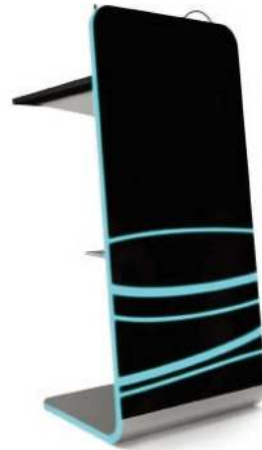

**WM-GE-BP06**  
500 x 600 x 1200 (H) mm



**WM-GE-BP05**  
600 x 550 x 1200 (H) mm



**WM-GE-BP01**  
600 x 550 x 1200 (H) mm



**WM-GE-BP02**  
600 x 550 x 1200 (H) mm



**WM-GE-BP07**  
600 x 550 x 1200 (H) mm



**WM-GE-BP08**  
600 x 530 x 1200 (H) mm





**WM-GE-BP09**  
600 x 530 x 1200 (H) mm

# THE ESSENTIALS

## BANQUET TABLE

### BANQUET TABLE - STAINLESS STEEL

ITEM	CODE	SIZE
<b>ROUND</b>		
	<b>WM-DE-BTSSR</b>	<b>Ø1830 X 760 mm</b>
<b>FAN - SHAPED</b>		
	<b>WM-DE-BTSSFS(S)</b>	<b>2103 x 760 x 760 mm</b>
	<b>WM-DE-BTSSFS(L)</b>	<b>2130 x 760 x 760 mm</b>
<b>RECTANGLE</b>		
	<b>WM-DE-BTSSR (S)</b>	<b>1830 x 455 x 760 mm</b>
	<b>WM-DE-BTSSR (M)</b>	<b>1830 x 760 x 760 mm</b>
	<b>WM-DE-BTSSR (L)</b>	<b>1830 x 915 x 760 mm</b>



**TROLLEY FOR ROUND TABLE**  
**WM-DE-TROT02**  
910 x 1866 x 1130 mm



**TROLLEY FOR RECTANGLE TABLE**  
**WM-DE-TRET01**  
910 x 1950 x 1137 mm

### ROUND TABLE COMBINATION

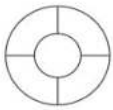

**Ø2740 x 760 mm**  
**WM-DE-BTSSC01**  
2150 (L) x 760 (W) x 760 (H) mm  
Outer Ø: 2740 mm  
Inner Ø: 1220 mm



**Ø3350 x 760 mm**  
**WM-DE-BTSSC02**  
2103 (L) x 760 (W) x 760 (H) mm  
Outer Ø: 3350 mm  
Inner Ø: 1830 mm

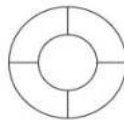

**Ø3660 x 760 mm**  
**WM-DE-BTSSC03**  
2873 (L) x 915 (W) x 760 (H) mm  
Outer Ø: 3660 mm  
Inner Ø: 1830 mm

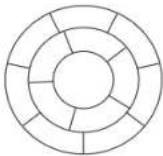

**Ø4870 x 760 mm**  
**WM-DE-BTSSC04**  
2103 (L) x 760 (W) x 760 (H) mm  
2130 (L) x 760 (W) x 760 (H) mm  
Outer Ø: 4870 mm  
Inner Ø: 1830 mm

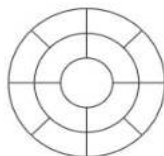

**Ø5490 x 760 mm**  
**WM-DE-BTSSC05**  
2873 (L) x 915 (W) x 760 (H) mm  
2154 (L) x 915 (W) x 760 (H) mm  
Outer Ø: 5490 mm  
Inner Ø: 1830 mm

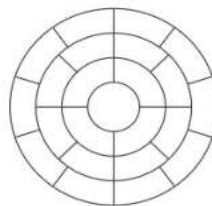





**Ø7320 x 760 mm**  
**WM-DE-BTSSC06**  
2873 (L) x 915 (W) x 760 (H) mm  
2154 (L) x 915 (W) x 760 (H) mm  
2298 (L) x 915 (W) x 760 (H) mm  
Outer Ø: 7320 mm  
Inner Ø: 1830 mm



# THE ESSENTIALS

## BANQUET TABLE



ITEM	CODE			SIZE	
					
ROUND - STEEL LEG	PVC	LEATHER	LAMINATED	D	H
	WM-DE-PVCRBT01	WM-DE-LERBT01	WM-DE-LARBT01	Ø915 X 760 mm	
	WM-DE-PVCRBT02	WM-DE-LERBT02	WM-DE-LARBT02	Ø1220 X 760 mm	
	WM-DE-PVCRBT03	WM-DE-LERBT03	WM-DE-LARBT03	Ø1530 X 760 mm	
	WM-DE-PVCRBT04	WM-DE-LERBT04	WM-DE-LARBT04	Ø1680 X 760 mm	
	WM-DE-PVCRBT05	WM-DE-LERBT05	WM-DE-LARBT05	Ø1830 X 760 mm	
	WM-DE-PVCRBT06	WM-DE-LERBT06	WM-DE-LARBT06	Ø2000 X 760 mm	
	WM-DE-PVCRBT07	WM-DE-LERBT07	WM-DE-LARBT07	Ø2200 X 760 mm	
HALF ROUND - STEEL LEG	PVC	LEATHER	LAMINATED	D	H
	WM-DE-PVCHRBT01	WM-DE-LEHRBT01	WM-DE-LAHRBT01	Ø915 X 760 mm	
	WM-DE-PVCHRBT02	WM-DE-LEHRBT02	WM-DE-LAHRBT02	Ø1220 X 760 mm	
	WM-DE-PVCHRBT03	WM-DE-LEHRBT03	WM-DE-LAHRBT03	Ø1530 X 760 mm	
	WM-DE-PVCHRBT04	WM-DE-LEHRBT04	WM-DE-LAHRBT04	Ø1680 X 760 mm	
	WM-DE-PVCHRBT05	WM-DE-LEHRBT05	WM-DE-LAHRBT05	Ø1830 X 760 mm	
	WM-DE-PVCHRBT06	WM-DE-LEHRBT06	WM-DE-LAHRBT06	Ø2000 X 760 mm	
	WM-DE-PVCHRBT07	WM-DE-LEHRBT07	WM-DE-LAHRBT07	Ø2200 X 760 mm	
	WM-DE-PVCHRBT08	WM-DE-LEHRBT08	WM-DE-LAHRBT08	Ø2440 X 760 mm	
	WM-DE-PVCHRBT09	WM-DE-LEHRBT09	WM-DE-LAHRBT09	Ø3000 X 760 mm	

# THE ESSENTIALS

## BANQUET TABLE



54 BANQUET

RECTANGLE - STEEL LEG	PVC	LEATHER	LAMINATED	L	W	H
-----------------------	-----	---------	-----------	---	---	---



WM-DE-PVCSLRBT01	WM-DE-LES LRBT01	WM-DE-LAS LRBT01	1830 x 455 x 760 mm
WM-DE-PVCSLRBT02	WM-DE-LES LRBT02	WM-DE-LAS LRBT02	1830 x 760 x 760 mm
WM-DE-PVCSLRBT03	WM-DE-LES LRBT03	WM-DE-LAS LRBT03	1830 x 9150 x 760 mm

FAN - SHAPED - STEEL LEG	PVC	LEATHER	LAMINATED	L	W	H
--------------------------	-----	---------	-----------	---	---	---



WM-DE-PVCSLFBT01	WM-DE-LES LFBT01	WM-DE-LAS LFBT01	2103 x 760 x 760 mm
WM-DE-PVCSLFBT02	WM-DE-LES LFBT02	WM-DE-LAS LFBT02	2130 x 760 x 760 mm
WM-DE-PVCSLFBT03	WM-DE-LES LFBT03	WM-DE-LAS LFBT03	2873 x 915 x 760 mm
WM-DE-PVCSLFBT04	WM-DE-LES LFBT04	WM-DE-LAS LFBT04	2154 x 915 x 760 mm
WM-DE-PVCSLFBT05	WM-DE-LES LFBT05	WM-DE-LAS LFBT05	2150 x 760 x 760 mm

1/4 ROUND - STEEL LEG	PVC	LEATHER	LAMINATED	L	W	H
-----------------------	-----	---------	-----------	---	---	---



WM-DE-PVCSL1/4RBT01	WM-DE-LES L1/4RBT01	WM-DE-LAS L1/4RBT01	455 x 455 x 760 mm
WM-DE-PVCSL1/4RBT02	WM-DE-LES L1/4RBT02	WM-DE-LAS L1/4RBT02	760 x 760 x 760 mm
WM-DE-PVCSL1/4RBT03	WM-DE-LES L1/4RBT03	WM-DE-LAS L1/4RBT03	915 x 915 x 760 mm

SQUARE - STEEL LEG	PVC	LEATHER	LAMINATED	L	W	H
--------------------	-----	---------	-----------	---	---	---



WM-DE-PVCSLSBT01	WM-DE-LES LSBT01	WM-DE-LAS LSBT01	760 x 760 x 760 mm
WM-DE-PVCSLSBT02	WM-DE-LES LSBT02	WM-DE-LAS LSBT02	915 x 915 x 760 mm
WM-DE-PVCSLSBT03	WM-DE-LES LSBT03	WM-DE-LAS LSBT03	1220 x 1220 x 760 mm

SQUARE-ROUND - STEEL LEG	PVC	LEATHER	LAMINATED	L	W	H
--------------------------	-----	---------	-----------	---	---	---



WM-DE-PVCSLSRBT01	WM-DE-LES LSRBT01	WM-DE-LAS LSRBT01	915/1220 x 915/1220 x 760 mm
-------------------	-------------------	-------------------	------------------------------

# THE ESSENTIALS

## CONFERENCE TABLE

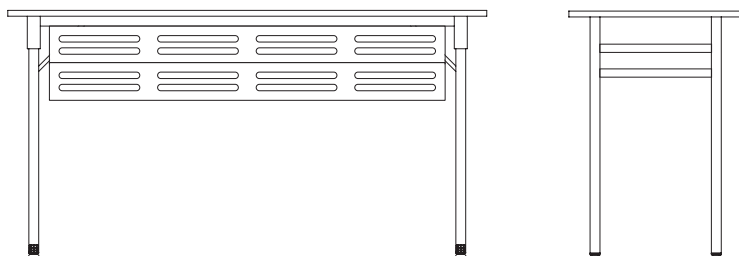

ITEM	CODE	SIZE
------	------	------



	L	W	H
<b>WM-DE-CTH01</b>	1830	455	760
<b>WM-DE-CTH02</b>	1830	600	760
<b>WM-DE-CTH03</b>	1830	760	760
<b>WM-DE-CTH04</b>	1830	915	760

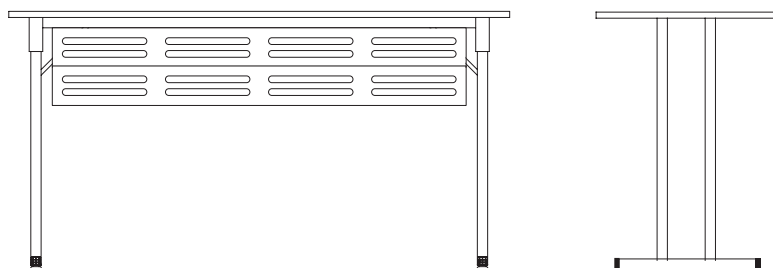

ITEM	CODE	SIZE
------	------	------



	L	W	H
<b>WM-DE-CTL01</b>	1830	455	760
<b>WM-DE-CTL02</b>	1830	600	760
<b>WM-DE-CTL03</b>	1830	760	760
<b>WM-DE-CTL04</b>	1830	915	760

# THE ESSENTIALS

## STAGE & DANCE FLOOR

ITEM	CODE	SIZE		
		L	W	H
	WM-DE-STDF-S01	2440	1220	410/610 mm
	WM-DE-STDF-S02	2440	1830	410/610 mm
	WM-DE-STDF-S03	2440	1830	610/812 mm



### ACCESSORIES FOR STAGE



**STAGE STEP (2 STEPS)**  
WM-DE-STDF-ST2  
978 x 628 x 486 mm



**STAGE STEP (3 STEPS)**  
WM-DE-STDF-ST3  
980 x 970 x 670 mm



**STAGE SKIRTING (WIDE)**  
WM-DE-STDF-SSW  
Matching 410 mm height stage



**STAGE SKIRTING (NARROW)**  
WM-DE-STDF-SSN  
Matching 610 mm height stage

ITEM	CODE	SIZE		
		L	W	H
	WM-DE-STDF-DF1	910	910	25 mm

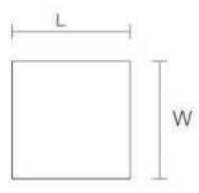

### ACCESSORIES FOR DANCE FLOOR



**CORNER TRIM**  
WM-DE-STDF-CT  
L 906 mm



**STRAIGHT TRIM**  
WM-DE-STDF-ST  
L 965 mm



**DANCE FLOOR TROLLEY**  
WM-DE-STDF-DFT  
1160 x 725 x 1055 mm



# THE ESSENTIALS

## RED CARPET & ROPE

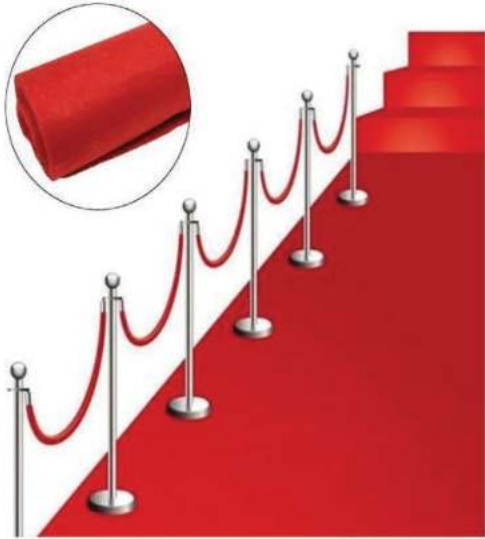

**Red Carpet**  
  
 122 x 500cm

### Rope & Pole Barriers



STAINLESS STEEL



**WM-GEX-SC08**  
 Dia: 30 x 97 (H) mm

BRASS



**WM-GEX-SC09**  
 Dia: 30 x 97 (H) mm

GOLD

**WM-GEX-SC10**  
 Dia: 30 x 97 (H) mm

STAINLESS STEEL

**WM-GEX-SC07**  
 Dia: 30 x 97 (H) mm



STAINLESS STEEL

**WM-GEX-SC01**  
 Dia: 30 x 96 (H) mm



GOLD

**WM-GEX-SC11**  
 Dia: 30 x 96 (H) mm

### RAILING ROPE



VELVET STYLE

**WM-GEX-RP01**  
 L 180 cm



ROPE STYLE

**WM-GEX-RP02**  
 L 180 cm

**B A R W A R E**

JIGGERS  
SHAKERS  
BAR SPOON  
BAR STRAINER  
MIXING GLASS  
BITTER BOTTLES  
BAR CADDY  
MUDDLER  
POURER  
ICE BUCKET  
ICE STANDS





ICE BUCKETS AND STANDS 







ICE BUCKET STAND  
WM-WB-COP  
ø27×28 (H)cm



ICE BUCKET STAND  
WM-WB-FUBLACK  
ø27×28 (H)cm



ICE BUCKET STAND  
WM-WB-STSA  
ø27×28 (H)cm



ICE BUCKET  
COPPER  
ø22×23 (H)cm



ICE BUCKET  
MATTE BLACK  
ø22×23 (H)cm



ICE BUCKET  
STAINLESS STEEL MIRROR  
ø22×23 (H)cm

Available in different finishes:  
satin  
matt  
stainless steel  
mirror



black



natural



walnut

# ICE BUCKETS AND STANDS

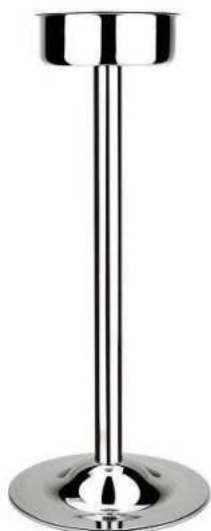

ICE BUCKET STAND  
WM-BW-017  
ø185×685(H)mm

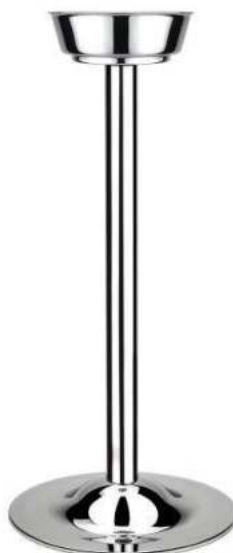

ICE BUCKET STAND  
WM-BW-017N  
ø170×675(H)mm

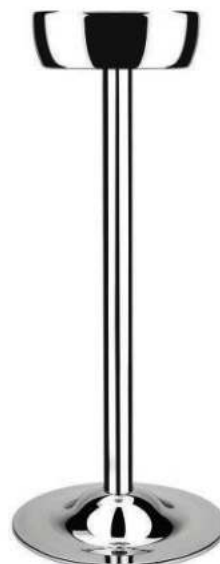

ICE BUCKET STAND  
WM-BW-017L  
ø205×685(H)mm



DOUBLE WALLED ICE BUCKET  
WM-BW.NM029  
4L



ICE BUCKET  
WM-BW-015  
4L



ICE BUCKET  
WM-BW-015L  
6L



DOUBLE WALLED ICE BUCKET WITH  
STAND  
WM-XPD311-10  
ø220×690(H)mm



DOUBLE WALLED ICE BUCKET WITH  
STAND  
WM-XPD311-1  
ø190×750(H)mm



DOUBLE WALLED ICE BUCKET WITH  
STAND  
WM-XPD311-2  
ø200×750(H)mm



ICE BUCKET WITH STAND  
WM-XPD311-3  
ø220×750(H)mm

# BAR SPOONS & SHAKERS

## Trident Cocktail Mixing Spoon

STAINLESS STEEL



BAR SPOON TRIDENT  
WM-BRSN0004-SS

400 mm

BAR SPOON TRIDENT  
WM-BRSN0007-SS

300 mm

## Teardrop Cocktail Mixing Spoon

STAINLESS STEEL



BAR SPOON TEARDROP  
WM-BRSN0015-SS

450mm

## Muddler Base Mixing Spoon

STAINLESS STEEL



BAR SPOON MUDDLERBASE  
WM-BRSN0018-SS

400mm

COPPER PLATED



BAR SPOON TRIDENT  
WM-BRSN0004-CP

400 mm

BAR SPOON TRIDENT  
WM-BRSN0007-CP

300 mm

COPPER PLATED



BAR SPOON TEARDROP  
WM-BRSN0015-CP

450mm

COPPER PLATED



BAR SPOON MUDDLER BASE  
WM-BRSN0018-CP

# BAR SHAKERS



3 PIECE SHAKER STAINLESS STEEL  
WM-CTSK0005-SS

550 ml



3 PIECE SHAKER COPPER  
WM-CTSK0005-CP

550 ml



WEIGHTED BOSTON SHAKER STAINLESS  
STEEL  
WM-CTSK0013-SS



WEIGHTED BOSTON SHAKER COPPER  
WM-CTSK0013-CP





# BAR TOOLS

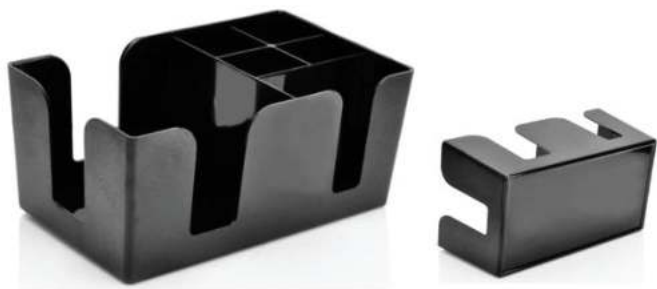

**BAR CADDY**  
**WM-BRCD0001**

  
24x14x10 (H) mm



**DOUBLE REACH CORKSCREW**  
**CEBP0002**

  
21 x 118 (H)mm

## POURER



**SPEED POURER**  
**WM-PORE0008**

  
101 (H)mm

## MUDDLER



**MUDDLER**  
**WM-MDLR0004-SS**

  
207 mm

## BLADE



**STAINLESS STEEL BAR BLADE**  
**WM-CEBP0005-SS**

  
40 x 178 (H)mm



**GOLD PLATED BAR BLADE**  
**WM-CEBP0005-GP**

  
40 x 178 (H)mm

# BAR TOOLS

## BARON STRAINER



BARON STRAINER  
WM-CTSN0001-CP  
  
165 x 100 mm



BARON STRAINER  
WM-CTSN0001-SS  
  
165 x 100 mm



## FINE STRAINER



FINE STRAINER  
WM-CTSN0010  
  
242 x 99 mm



## JULEP STRAINER



JULEP STRAINER  
WM-CTSN0005-SS  
  
160 x 80mm



JULEP STRAINER  
WM-CTSN0005-CP  
  
160 x 80mm

# BAR TOOLS

JAPANESE JIGGER 30/60 ML  
WM-MSAS0020-CP



44 x 46 x 122 (H) mm

JAPANESE JIGGER 30/60 ML  
WM-MSAS0020-SS



44 x 46 x 122 (H) mm

SLIM DOUBLE JIGGER 30/45ML  
WM-MSAS0016-SS



114 (H) mm

SLIM DOUBLE JIGGER 60/90ML  
WM-MSAS0018-SS



158 (H) mm

## BITTER BOTTLES



BITTER BOTTLES  
WM-DSBT0001  
50ml



BITTER BOTTLES

BITTER BOTTLES  
WM-DSBT0003  
90ml



BITTER BOTTLES  
WM-DSBT0006  
90ml

## MIXING GLASS



MIXING GLASS  
WM-MXGS0002

600 ml



90 x 136 (H) mm



MIXING GLASS  
WM-MXGS0010

650 ml



102 x 157 (H) mm

Manifested through the excellence of Titanium Technology, Wild Magma's glassware range reflects durability, poise, and brilliance. The intrinsic detailing and refined finish along with a sturdy body makes Wild Magma's glassware range stronger than others by 35%

## G L A S S W A R E

OCEAN

FLUID

PURE

FLOW

TIDE

SPRING

SPLASH

MOSCOW MULE





RED WINE  
WM-COC-RW450  
450ml

Goblet  
WM-COC-RW550  
550ml

WHITE WINE  
WM-COC-WW350  
350ml



# OCEAN

'Treasures are hidden in the depth of the oceans.' The tulip-shaped curves of the glass, and a profound design make the ocean range distinctively unique, specifically formed to maximise enjoyment of the favoured drink. Inspired by the many facets of the ocean, the pieces resemble an enigma of all things exclusive.



WHITE WINE  
WM-COC-WW350

350ml



84 x 84 x 226 (H) mm



RED WINE  
WM-COC-RW450

450ml



89 x 89 x 237 (H) mm



Goblet  
WM-COC-RW550

550ml



96 x 96 x 252 (H) mm



Burgundy  
WM-COC-RW570

570ml



105 x 105 x 222 (H) mm



CHAMPAGNE FLUTE  
WM-CPR-CF200

200ml



66 x 66 x 244 (H) mm



BEER GLASS  
WM-COC-B380

380ml



87 x 87 x 172 (H) mm



BEER GLASS  
WM-COC-B540

540ml



96 x 96 x 195 (H) mm





# FLUID

Swaying in the grandeur of being timeless and sophisticated, the flow collection depicts the stunning pieces exploring the vintage take on glassware. These classics are for every mood and season. Be prepared to experience grace in its finest.



WHITE WINE  
WM-CFL-WW360

360ml



89 x 89 x 231(H) mm



RED WINE (AP)  
WM-CFL-RW460

460ml



94 x 94 x 237 (H) mm



RED WINE  
WM-CFL-RW560

560ml



99 x 99 x 244 (H) mm



CHAMPAGNE FLUTE  
WM-CFL-RW210

210ml



70 x 70 x 263 (H) mm



COUPE  
WM-CFL-R20007

220ml



97 x 97 x 170 (H) mm



LOW TUMBLER  
WM-CFL-RW350

350ml



91 x 91 x 99 (H) mm



LOW TUMBLER  
WM-CFL-RW350

400ml



91 x 91 x 125 (H) mm



RED WINE (AP)  
WM-CPR-RW450  
450ml

# PURE

The feel of simplicity with an aura of urban charm; the pure range balances the flow and fall collection by beautifully blending the aesthetics. It's a seamless integration for the seekers of refined novelty.

---



**WHITE WINE**  
**WM-CPR-WW250**

250ml



**WHITE WINE**  
**WM-CPR-RW360**

360ml



83 x 83 x 220 (H) mm



**RED WINE (AP)**  
**WM-CPR-RW450**

450ml



90 x 90 x 225 (H) mm



**RED WINE**  
**WM-CPR-RW580**

580ml



99 x 99 x 230 (H) mm



**RED WINE**  
**WM-CPR-RW600**

600ml



105 x 105 x 215 (H) mm



**CHAMPAGNE FLUTE**  
**WM-CPR-CF200**

200ml



66 x 66 x 244 (H) mm



Gin tonic @Masti Dubai

WM-CFL-RW570

570ml



# FLOW

Swaying in the grandeur of being timeless and sophisticated, the flow collection depicts the stunning pieces exploring the vintage take on glassware. These classics are for every mood and season. Be prepared to experience grace in its finest.



WHITE WINE  
WM-CFL-WW350

350ml



81 x 81 x 222 (H) mm



RED WINE (AP)  
WM-CFL-RW450

450ml



87 x 87 x 224 (H) mm



RED WINE  
WM-CFL-RW570

570ml



104 x 104 x 206 (H) mm



RED WINE  
WM-CFL-RW580

580ml



95 x 95 x 235 (H) mm



RED WINE  
WM-CFL-RW650

650ml



107 x 107 x 222 (H) mm



CHAMPAGNE FLUTE  
WM-CFL-CF220

220ml



66 x 66 x 242 (H) mm

HIGH BALL  
WM-CFL-HB470

470ml



# FLOW



**SHOT GLASS**  
**WM-CFL-SG50**

50ml



50 x 50 x 50 (H) mm



**OLD FASHION**  
**WM-CFL-OF320**

320ml



91 x 91 x 91 (H) mm



**COGNAC**  
**WM-CFL-C690**

690ml



112 x 112 x 155 (H) mm



**HIGH BALL**  
**WM-CFL-HB300**

300ml



79 x 79 x 110 (H) mm



**HIGH BALL**  
**WM-CFL-HB470**

470ml



91 x 91 x 127 (H) mm



**BEER**  
**WM-CFL-B380**

380ml



72 x 72 x 187 (H) mm







BEER GLASS  
WM-CPR-B380

380ml



70 x 70 x 208 (H) mm



SHOT GLASS  
WM-CPR-SG60

60ml



52 x 52 x 58 (H) mm



OLD FASHION  
WM-CPR-OF230

230ml



77 x 77 x 77 (H) mm



DOUBLE OLD FASHION  
WM-CPR-DOF290

290ml



81 x 81 x 88 (H) mm



HIGH BALL  
WM-CPR-HB250

250ml



66 x 66 x 115 (H) mm



HIGH BALL  
WM-CPR-HB380

380ml



76 x 76 x 130 (H) mm



**BIGH BALL**  
**WM-CT-HB470**  
470ml

'Sturdy and Bold,' the tide collection is all about embracing minimalism yet being noticed. It's the masculine shape and an ever-charming avatar that makes it a good pick for any kind of beverage.

---



**OLD FASHION  
WM-CT-OF320**

320ml



80 x 80 x 99 (H) mm



**OLD FASHION  
WM-CT-OF410**

410ml



90 x 90 x 95 (H) mm



**JUICE GLASS  
WM-CT-JG150**

150ml



58 x 58 x 96 (H) mm



**HIGH BALL  
WM-CT-HB350**

350ml



69 x 69 x 151 (H) mm



**HIGH BALL  
WM-CT-HB470**

470ml



71 x 71 x 160 (H) mm





# COUPE



**Coupe**  
**WM-24002020**

240ml



90 x 61 x 170 (H) mm



**NICK & NORA PLATINUM**  
**WM-P67095**

170ml



76 x 76 x 149 (H) mm



**NICK & NORA BOTANIST**  
**WM-CT-R90730**

170ml



75 x 75 x 150 (H) mm



**NICK & NORA HAYWORTH**  
**WM-PR90240**

170ml



75 x 75 x 150 (H) mm



**RAFFLES LINES NICK AND NORA**  
**WM-R90703**

170ml



75 x 75 x 150 (H) mm



**RAFFLES DIAMOND NICK AND NORA**  
**WM-R90704**

170ml



75 x 75 x 150 (H) mm



**RAFFLES VINTAGE NICK AND NORA**  
**WM-R90705**

170ml



75 x 75 x 150 (H) mm



**HUDSON NICK & NORA**  
**WM-P440393**

170ml



75 x 75 x 165 (H) mm



SPLASH COLLECTION  
WM-CS-WBS000

# SPLASH

 24% LEAD CRYSTAL  
HANDCRAFTED

Add the glitz and glamour quotient with the splash collection that oozes an old-fashioned charm packaged in a modern look. The classic bottle and glass range is an outcome of craftsmanship that understands the soul of everything regal.



SPLASH  
WM-CS-WBS000  
  
310 (H) mm



DECANTER  
350ml  
  
83 x 83 x 170 (H) mm



GLASSES  
250ml  
  
80 x 80 x 73 (H) mm

---

## COLOURED GLASSES



Grey  
WM-CO-GR01  
305ml  

top dia 84 x bottom dia 64 x 92 (H) mm



Blue  
WM-CO-BL02  
305ml  

top dia 84 x bottom dia 64 x 92 (H) mm



Magenta  
WM-CO-MA01  
305ml  

top dia 84 x bottom dia 64 x 92 (H) mm



Grey  
WM-CO-GR02  
250ml  

top dia 78 x bottom dia 58 x 96 (H) mm



Vintage brown  
WM-CO-BR01  
250ml  

top dia 78 x bottom dia 58 x 96 (H) mm

Moscow Mule

Cocktail creation by Tauland Hyka



WILD MAGMA  
MOSCOW MULE

80 X 80 X 110 (H) mm



# MOSCOW MULE



MOSCOW MULE

COPPER



80 x 80 X 110(H) mm

MULE  
WM-F93013  
360 ml



Copper mule  
WM-F91072  
360 ml



# F L A T W A R E

AIR VINTAGE

AIR VINTAGE COPPER

AIR GOLD

AIR

BREEZE VINTAGE

BREEZE COPPER

BREEZE BLACK

WIND COPPER

WIND BLACK

WIND VINTAGE



AIR VINTAGE COLLECTION

18/10 Stainless Steel





# AIR VINTAGE

The magic of the vintage era is manifested through these matt cutleries. Sleek and sober; they can be paired with any dinnerware and look magnificent each time.



**TABLE KNIFE**  
**WM-FAIRV-TK01**

18/10 Stainless Steel

**Texture:**  
Brushed Finish



10 mm  
223 mm



**TABLE FORK**  
**WM-FAIRV-TF01**

18/10 Stainless Steel

**Texture:**  
Brushed Finish



2.5 mm  
204 mm



**TABLE SPOON**  
**WM-FAIRV-TS01**

18/10 Stainless Steel

**Texture:**  
Brushed Finish



2.5 mm  
204 mm



**DESSERT KNIFE**  
**WM-FAIRV-DK02**

18/10 Stainless Steel

**Texture:**  
Brushed Finish



9 mm  
205 mm



**DESSERT FORK**  
**WM-FAIRV-DF02**

18/10 Stainless Steel

**Texture:**  
Brushed Finish



2 mm  
174 mm



**DESSERT SPOON**  
**WM-FAIRV-DS02**

18/10 Stainless Steel

**Texture:**  
Brushed Finish



2 mm  
173 mm



**TEA SPOON**  
**WM-FAIRV-TS03**

18/10 Stainless Steel

**Texture:**  
Brushed Finish



1.5 mm  
131 mm



**COFFEE SPOON**  
**WM-FAIRV-CS04**

18/10 Stainless Steel

**Texture:**  
Brushed Finish



1.5 mm  
105 mm



AIR VINTAGE COPPER COLLECTION

18/10 Stainless Steel

# AIR VINTAGE COPPER

'Rustic, Rugged, and Refined', it's the vividness of the perfect copper tone that makes this flatware irresistible. This antique inspired collection is a subtle reflection of rural elements presented in an urban way.



**TABLE KNIFE**  
**WM-FAIRVC-TK01**

18/10 Stainless Steel

**Texture:**  
Brushed Finish



10 mm  
223 mm



**TABLE FORK**  
**WM-FAIRVC-TF01**

18/10 Stainless Steel

**Texture:**  
Brushed Finish



2.5 mm  
204 mm



**TABLE SPOON**  
**WM-FAIRVC-TS01**

18/10 Stainless Steel

**Texture:**  
Brushed Finish



2.5 mm  
204 mm



**DESSERT KNIFE**  
**WM-FAIRVC-DK02**

18/10 Stainless Steel

**Texture:**  
Brushed Finish



9 mm  
205 mm



**DESSERT FORK**  
**WM-FAIRVC-DF02**

18/10 Stainless Steel

**Texture:**  
Brushed Finish



2 mm  
174 mm



**DESSERT SPOON**  
**WM-FAIRVC-DS02**

18/10 Stainless Steel

**Texture:**  
Brushed Finish



2 mm  
173 mm



**TEA SPOON**  
**WM-FAIRVC-TS03**

18/10 Stainless Steel

**Texture:**  
Brushed Finish



1.5 mm  
131 mm



**COFFEE SPOON**  
**WM-FAIRVC-CS04**

18/10 Stainless Steel

**Texture:**  
Brushed Finish



1.5 mm  
105 mm







# AIR GOLD

The gold mirror finish of the air collection is the elegance in definition . The stunning gold finish and elegant shape define the simplistic design and tough durability.



**TABLE KNIFE (HEAVY HANDLE)**  
**WM-FAIR-ZR-TK01B**

18/10 Stainless Steel

**Texture:**  
Gold Mirror Finish



10 mm  
238 mm



**TABLE KNIFE**  
**WM-FAIR-ZR-TK03S**

18/10 Stainless Steel

**Texture:**  
Gold Mirror Finish



10 mm  
223 mm



**TABLE FORK**  
**WM-FAIR-ZR-TF01**

18/10 Stainless Steel

**Texture:**  
Gold Mirror Finish



2.5 mm  
204 mm



**TABLE SPOON**  
**WM-FAIR-ZR-TS01**

18/10 Stainless Steel

**Texture:**  
Gold Mirror Finish



2.5 mm  
204 mm



**DESSERT KNIFE**  
**WM-FAIR-ZR-DK02**

18/10 Stainless Steel

**Texture:**  
Gold Mirror Finish



9 mm  
205 mm



**DESSERT FORK**  
**WM-FAIR-ZR-DF02**

18/10 Stainless Steel

**Texture:**  
Gold Mirror Finish



2 mm  
174 mm



**DESSERT SPOON**  
**WM-FAIR-ZR-DS02**

18/10 Stainless Steel

**Texture:**  
Gold Mirror Finish



2 mm  
173 mm



**TEA SPOON**  
**WM-FAIR-ZR-TS03**

18/10 Stainless Steel

**Texture:**  
Gold Mirror Finish



1.5 mm  
131 mm



**COFFEE SPOON**  
**WM-FAIR-ZR-CS04**

18/10 Stainless Steel

**Texture:**  
Gold Mirror Finish



1.5 mm  
105 mm



AIR COLLECTION

18/10 Stainless Steel

The stainless-steel mirror finish of the air collection is an attraction at first sight. The stunning design and elegant shape define the simplistic design and tough durability.



**TABLE KNIFE (HEAVY HANDLE)**  
**WM-FAIR-TK01B**

18/10 Stainless Steel

**Texture:**  
Mirror Finish



**10 mm**  
**238 mm**



**TABLE KNIFE**  
**WM-FAIR-TK03S**

18/10 Stainless Steel

**Texture:**  
Mirror Finish



**10 mm**  
**223 mm**



**TABLE FORK**  
**WM-FAIR-TF01**

18/10 Stainless Steel

**Texture:**  
Mirror Finish



**2.5 mm**  
**204 mm**



**TABLE SPOON**  
**WM-FAIR-TS01**

18/10 Stainless Steel

**Texture:**  
Mirror Finish



**2.5 mm**  
**204 mm**



**DESSERT KNIFE**  
**WM-FAIR-DK02**

18/10 Stainless Steel

**Texture:**  
Mirror Finish



**9 mm**  
**205 mm**



**DESSERT FORK**  
**WM-FAIR-DF02**

18/10 Stainless Steel

**Texture:**  
Mirror Finish



**2 mm**  
**174 mm**



**DESSERT SPOON**  
**WM-FAIR-DS02**

18/10 Stainless Steel

**Texture:**  
Mirror Finish



**2 mm**  
**173 mm**



**TEA SPOON**  
**WM-FAIR-TS03**

18/10 Stainless Steel

**Texture:**  
Mirror Finish



**1.5 mm**  
**131 mm**



**COFFEE SPOON**  
**WM-FAIR-CS04**

18/10 Stainless Steel

**Texture:**  
Mirror Finish



**1.5 mm**  
**105 mm**



BREEZEVINTAGE COLLECTION

18/10 Stainless Steel



# BREEZE VINTAGE

The delicacy of this collection is a skilled outcome of the artisans that have carefully shaped every aspect of it. A touch of novelty and a piece of art, the breeze vintage collection is a timeless treasure for the ones who appreciate all things splendid.



**TABLE KNIFE**  
**WM-AMFBV-TK01**

18/10 Stainless Steel

**Texture:**  
Brushed Finish



240 mm



**TABLE FORK**  
**WM-AMFBV-TF01**

18/10 Stainless Steel

**Texture:**  
Brushed Finish



200 mm



**TABLE SPOON**  
**WM-AMFBV-TS01**

18/10 Stainless Steel

**Texture:**  
Brushed Finish



202 mm



**DESSERT KNIFE**  
**WM-AMFBV-DK02**

18/10 Stainless Steel

**Texture:**  
Brushed Finish



218 mm



**DESSERT FORK**  
**WM-AMFBV-DF02**

18/10 Stainless Steel

**Texture:**  
Brushed Finish



185 mm



**DESSERT SPOON**  
**WM-AMFBV-DS02**

18/10 Stainless Steel

**Texture:**  
Brushed Finish



187 mm



**TEA SPOON**  
**WM-AMFBV-TS03**

18/10 Stainless Steel

**Texture:**  
Brushed Finish



142 mm



**COFFEE SPOON**  
**WM-AMFBV-CS04**

18/10 Stainless Steel

**Texture:**  
Brushed Finish



110 mm

**HALF VINTAGE | MIRROR FINISH**  
**WM-AMFBV-MR**



# BREEZE COPPER

Created from the finest resources by skilled craftsmen, the breeze collection mirrors the rustic charisma and delicacy of a fine work of art.



**TABLE KNIFE**  
**WM-AMFBC-TK01**

18/10 Stainless Steel

**Texture:**  
Brushed Finish



240 mm



**TABLE FORK**  
**WM-AMFBC-TF01**

18/10 Stainless Steel

**Texture:**  
Brushed Finish



200 mm



**TABLE SPOON**  
**WM-AMFBC-TS01**

18/10 Stainless Steel

**Texture:**  
Brushed Finish



202 mm



**DESSERT KNIFE**  
**WM-AMFBC-DK02**

18/10 Stainless Steel

**Texture:**  
Brushed Finish



218 mm



**DESSERT FORK**  
**WM-AMFBC-DF02**

18/10 Stainless Steel

**Texture:**  
Brushed Finish



185 mm



**DESSERT SPOON**  
**WM-AMFBC-DS02**

18/10 Stainless Steel

**Texture:**  
Brushed Finish



187 mm



**TEA SPOON**  
**WM-AMFBC-TS03**

18/10 Stainless Steel

**Texture:**  
Brushed Finish



142 mm



**COFFEE SPOON**  
**WM-AMFBC-CS04**

18/10 Stainless Steel

**Texture:**  
Brushed Finish



110 mm

**HALF COPPER | BRUSHED FINISH**  
**WM-AMFBC-MT**



This collection is available in two more variants:  
matt finish and mirror finish.

# BREEZE BLACK

It's easier to complement dinnerware with the hand-made breeze black collection. Giving an edge look to the usual cutlery, it's sure to fetch the appreciation one seeks.



**TABLE KNIFE**  
**WM-AMFBB-TK01**

18/10 Stainless Steel

**Texture:**  
Brushed Finish



240 mm



**TABLE FORK**  
**WM-AMFBB-TF01**

18/10 Stainless Steel

**Texture:**  
Brushed Finish



200 mm



**TABLE SPOON**  
**WM-AMFBB-TS01**

18/10 Stainless Steel

**Texture:**  
Brushed Finish



202 mm



**DESSERT KNIFE**  
**WM-AMFBB-DK02**

18/10 Stainless Steel

**Texture:**  
Brushed Finish



218 mm



**DESSERT FORK**  
**WM-AMFBB-DF02**

18/10 Stainless Steel

**Texture:**  
Brushed Finish



185 mm



**DESSERT SPOON**  
**WM-AMFBB-DS02**

18/10 Stainless Steel

**Texture:**  
Brushed Finish



187 mm



**TEA SPOON**  
**WM-AMFBB-TS03**

18/10 Stainless Steel

**Texture:**  
Brushed Finish



142 mm



**COFFEE SPOON**  
**WM-AMFBB-CS04**

18/10 Stainless Steel

**Texture:**  
Brushed Finish



110 mm

**HALF BLACK | BRUSHED FINISH**  
**WM-AMFBB-MT**



This collection is available in two more variants:  
matt finish and mirror finish.



WIND VINTAGE COPPER COLLECTION

18/10 Stainless Steel



# WIND COPPER

The beauty of this collection lies in the skilled craftsmanship of artists that make each item look beyond perfect. The copper tone adds the opulence required for formal occasions and events.



**TABLE KNIFE**  
**WM-AMFWC-TK01**

18/10 Stainless Steel

**Texture:**  
Brushed Finish



240 mm



**TABLE FORK**  
**WM-AMFWC-TF01**

18/10 Stainless Steel

**Texture:**  
Brushed Finish



200 mm



**TABLE SPOON**  
**WM-AMFWC-TS01**

18/10 Stainless Steel

**Texture:**  
Brushed Finish



202 mm



**DESSERT KNIFE**  
**WM-AMFWC-DK02**

18/10 Stainless Steel

**Texture:**  
Brushed Finish



218 mm



**DESSERT FORK**  
**WM-AMFWC-DF02**

18/10 Stainless Steel

**Texture:**  
Brushed Finish



185 mm



**DESSERT SPOON**  
**WM-AMFWC-DS02**

18/10 Stainless Steel

**Texture:**  
Brushed Finish



187 mm



**TEA SPOON**  
**WM-AMFWC-TS03**

18/10 Stainless Steel

**Texture:**  
Brushed Finish



142 mm



**COFFEE SPOON**  
**WM-AMFWC-CS04**

18/10 Stainless Steel

**Texture:**  
Brushed Finish



110 mm

**HALF COPPER | BRUSHED FINISH**  
**WM-AMFWC-MT**





WIND BLACK MATT COLLECTION

WM-AMFWB-MT

# WIND BLACK

'Commanding an authority and establishing an assertion' is the inspiration behind the wind black collection. The design is enduring with the essence of modern dynamics.



**TABLE KNIFE**  
**WM-AMFWB-TK01**

18/10 Stainless Steel

**Texture:**  
Brushed Finish



240 mm



**TABLE FORK**  
**WM-AMFWB-TF01**

18/10 Stainless Steel

**Texture:**  
Brushed Finish



200 mm



**TABLE SPOON**  
**WM-AMFWB-TS01**

18/10 Stainless Steel

**Texture:**  
Brushed Finish



202 mm



**DESSERT KNIFE**  
**WM-AMFWB-DK02**

18/10 Stainless Steel

**Texture:**  
Brushed Finish



218 mm



**DESSERT FORK**  
**WM-AMFWB-DF02**

18/10 Stainless Steel

**Texture:**  
Brushed Finish



185 mm



**DESSERT SPOON**  
**WM-AMFWB-DS02**

18/10 Stainless Steel

**Texture:**  
Brushed Finish



187 mm



**TEA SPOON**  
**WM-AMFWB-TS03**

18/10 Stainless Steel

**Texture:**  
Brushed Finish



142 mm



**COFFEE SPOON**  
**WM-AMFWB-CS04**

18/10 Stainless Steel

**Texture:**  
Brushed Finish



110 mm

**HALF BLACK | BRUSHED FINISH**  
**WM-AMFWB-MT**



# WIND VINTAGE

'Classiques' are timeless. The sleek body of the Wind Vintage collection resonates the old world glory that artistically transforms even the simplest creations to avant-garde.



**TABLE KNIFE**  
**WM-AMFWV-TK01**

18/10 Stainless Steel

**Texture:**  
Brushed Finish



240 mm



**TABLE FORK**  
**WM-AMFWV-TF01**

18/10 Stainless Steel

**Texture:**  
Brushed Finish



200 mm



**TABLE SPOON**  
**WM-AMFWV-TS01**

18/10 Stainless Steel

**Texture:**  
Brushed Finish



202 mm



**DESSERT KNIFE**  
**WM-AMFWV-DK02**

18/10 Stainless Steel

**Texture:**  
Brushed Finish



218 mm



**DESSERT FORK**  
**WM-AMFWV-DF02**

18/10 Stainless Steel

**Texture:**  
Brushed Finish



185 mm



**Texture:**  
Brushed Finish



187 mm



**TEA SPOON**  
**WM-AMFWV-TS03**

18/10 Stainless Steel

**Texture:**  
Brushed Finish



142 mm



**COFFEE SPOON**  
**WM-AMFWV-CS04**

18/10 Stainless Steel

**Texture:**  
Brushed Finish



110 mm

**HALF VINTAGE | BRUSHED FINISH**  
**WM-AMFWV-MT**





# T A B L E T O P & A C C E S S O R I E S

HIGH TEA STANDS

ASHTRAYS

NAPKIN HOLDER

PLACEMATS

SALT & PEPPER MILLS

OIL & VINEGAR

RESIN ART BOARDS

SERVING BOARDS

# HIGH TEA STANDS

HIGH TEA STAND  
Customized for FOUR SEASONS DIFC DUBAI



TABLEWARE ACCESSORIES 110

HIGH TEA STAND  
Stainless steel with porcelain plates  
customizable





HIGH TEA STAND  
Stainless steel



HIGH TEA STAND  
Stainless steel with glass plates



# HIGH TEA STANDS



HIGH TEA STAND  
Stainless steel & Customizable colour





An understated and elegant way to present afternoon tea. This three-tier floor standing tea stand is made from a high polished square bar with formed circles and arches. Each tea stand has been manufactured to our exacting standards. Fully customizable to uour needs!



HIGH TEA STAND  
GOLD

HIGH TEA STAND  
BLACK

HIGH TEA STAND  
BROWN



HIGH TEA STAND  
white drawer



HIGH TEA STAND  
white drawer



COPPER  
WM-NWCASH-CP01  
Zinc Alloy

# ASHTRAYS

Setting the mood and vibe right, the ashtray collection by Wild Magma comes in three gorgeous tones. These enduring ashtrays tell a story about the subtle boundary between the timeless and trendy.



**SILVER**  
**WM-NWCASH-CH01**  
Zinc Alloy  
82 x 82 x 45 (H) mm



**BRONZE**  
**WM-NWBASH-BR01**  
Zinc Alloy  
82 x 82 x 45 (H) mm



**COPPER**  
**WM-NWCASH-CP01**  
Zinc Alloy  
82 x 82 x 45 (H) mm



**GOLD MIRROR FINISH**  
**WM-NWGASH-GD01**  
Zinc Alloy  
82 x 82 x 45 (H) mm



**CHROME**  
**WM-NSQASH-CH01**  
71 x 71 x 45 (H) mm  
Zinc Alloy



**BRONZE**  
**WM-NSQASH-BR01**  
71 x 71 x 45 (H) mm  
Zinc Alloy



**COPPER**  
**WM-NSQASH-CP01**  
71 x 71 x 45 (H) mm  
Zinc Alloy



**BRONZE 16 holes**  
**WM-NWGASH-BR02**  
94 x 94 x 45 (H) mm  
Zinc Alloy



**SILVER**  
**WM- KIM01**  
top 70 x bottom 82 x 70 (H) mm  
Stainless Steel  
windproof



**GOLD**  
**WM- KIM02**  
top 70 x bottom 82 x 70 (H) mm  
Stainless Steel  
windproof



**Black**  
**WM- KIM04**  
top 70 x bottom 82 x 70 (H) mm  
Stainless Steel  
windproof



**ROSE GOLD**  
**WM- KIM03**  
top 70 x bottom 82 x 70 (H) mm  
Stainless Steel  
windproof



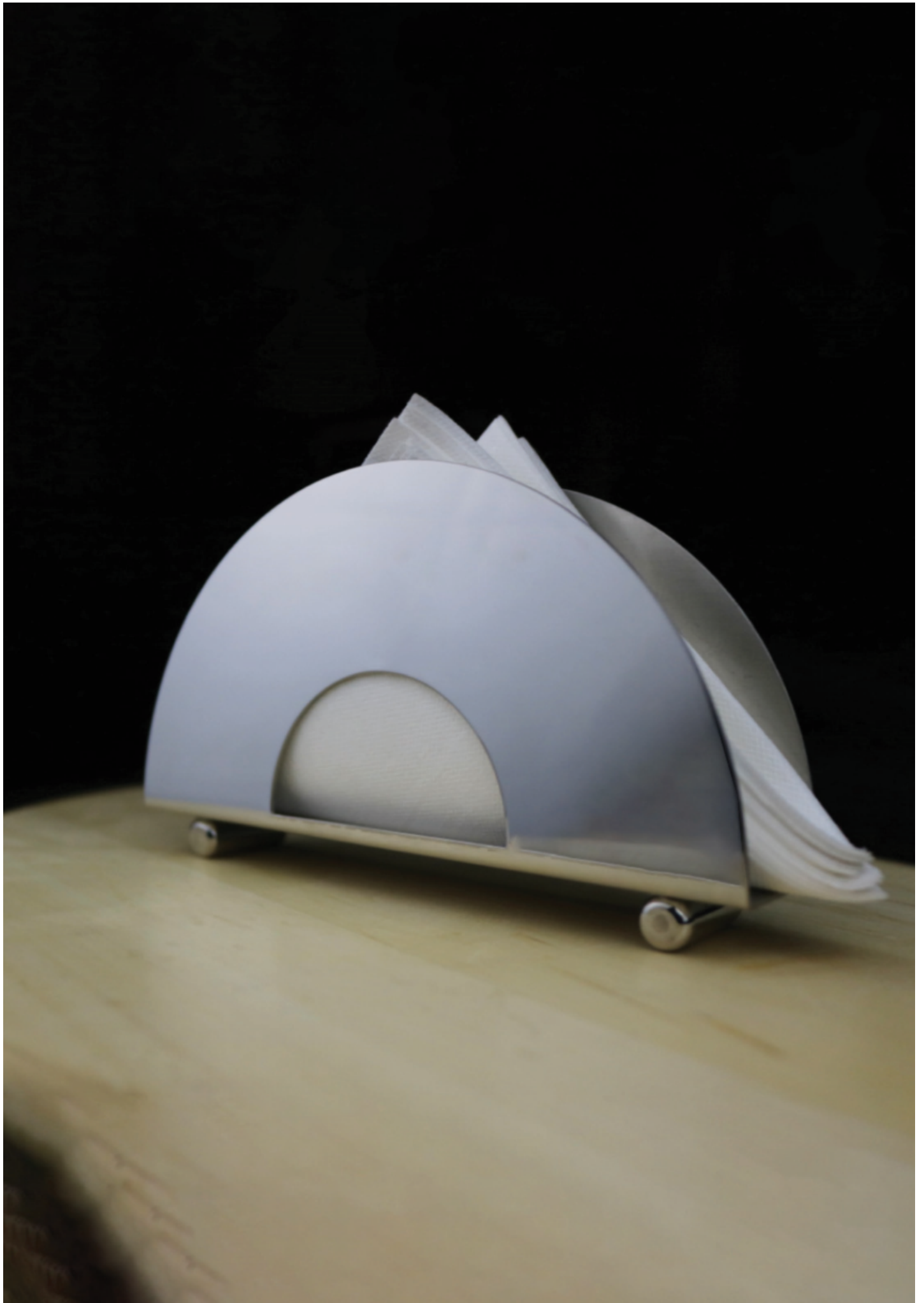



# NAPKIN HOLDER



Gold  
**WM-KIM09**  
stainless steel  
**Texture:**  
Stainless Steel Finish  
  
110 x 31 x 85 (H) mm



Silver  
**WM-KIM08**  
stainless steel  
**Texture:**  
Stainless Steel Finish  
  
110 x 31 x 85 (H) mm



Gold  
**WM-KIM06**  
stainless steel  
  
110 x 32 x 70 (H) mm



Silver  
**WM-KIM05**  
stainless steel  
  
110 x 32 x 70 (H) mm



ROSE Gold  
**WM-KIM07**  
stainless steel  
  
110 x 32 x 70 (H) mm



Silver  
**WM-KIM10**  
stainless steel  
**Texture:**  
silver mirror finish  
  
150mm x 38 (H) mm



Ash PLACEMAT  
WM-ZPM-ASH01  
Vryl

# PLACEMATS

Modern dining etiquette gives significance to well-placed mats. The vinyl textured place mats boost the table setting. The variants match every space and setting. Created by using finest materials, they are long-lasting and easy to maintain.

---



AIR  
**WM-ZPM-AIR01**

Vinyl



300 x 450 mm



ASH  
**WM-ZPM-ASH01**

Vinyl



300 x 450 mm



COAL  
**WM-ZPM-COAL01**

Vinyl



300 x 450 mm



WOOD  
**WM-ZPM-WOOD01**

Vinyl



300 x 450 mm

NATURE

WM-MSP-NAS01 (SALT) | WM-MSP-NAP01 (PEPPER)

Wood with Ceramic Grinder





# SALT & PEPPER MILLS

The slender and stylish salt and pepper mill collection ooze simplicity and functionality. Colour and size variants make it a convenient choice.



**NATURE**  
**(SALT) WM-MSP-NAS01 | (PEPPER) WM-MSP-NAP01**

Wood with Ceramic Grinder

**Texture:**  
Wood Finish | Natural Color

  
100 mm



**BEECH**  
**(SALT) WM-MSP-BES01 | (PEPPER) WM-MSP-BEP01**

Wood with Ceramic Grinder

**Texture:**  
Wood Finish | Dark Brown

  
100 mm

COMET  
WM-MSP-CBC01  
Glass



# OIL & VINEGAR

The stylish avatar embodies a delicate balance between creativity and usability. The novel shape and the unique conceptualization of these cruets call for a second look. For culinary critics, these cruets are sure to elevate the dining experience.

---



SPHERE  
WM-MSP-CBC01

Glass



110 x 110 x 125 (H)mm



COMET  
WM-MSP-CBC02

Glass



110 x 110 x 145 (H)mm



CLUSTER  
WM-MSP-CBC03

Glass



80 x 80 x 125 (H)mm

RESIN ART 

TABLEWARE ACCESSORIES 124





# RESIN ART BOARDS

Each board is created handmade with unique resin art design, fully customizable with acacia wood boards or small and big trays custom made for your interior and design.

Heat resistant, scratch resistant, water resistant  
Non-Toxic, 100% natural and eco friendly

The boards are hand washed with water with the use of non-aggressive types of cleaner that are also used for washing dishes.

*\*After washing, wipe with a dry cloth and put vertically to dry at a natural temperature.*



**Resin Art  
WM-WB-BLUE**

**Texture:**  
high quality coating resin





ELM  
WM-WOE-FD  
Wood

# SERVING BOARDS

The range boasts of durability and style. The toughness is a result of teak wood that gives the board a long life. The many shapes and textures offer an added advantage for chopping or serving.



ELM  
WM-WOE-FD

Wood

**Texture:**  
Wood Oak

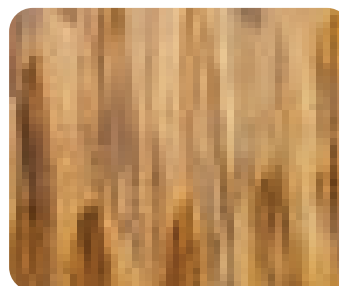

430 x 120 x 25 mm

Boards are boiled in linseed oil - this antiseptic protects the board from moisture and fungus, and also prevents the board from drying out. The boards are hand washed with water with the use of non-aggressive types of cleaner that are also used for washing dishes.

*\*After washing, wipe with a dry cloth and put vertically to dry at a natural temperature.*



LEAF  
WM-WOL-BB

Wood

**Texture:**  
Wood Oak



400 x 200 x 25 mm



STUMP (1ST SIDE)  
WM-WOS-2SB  
Wood



# SERVING BOARDS

The range boasts of durability and style. The toughness is a result of teak wood that gives the board a long life. The many shapes and textures offer an added advantage for chopping or serving.



**STUMP (1ST SIDE)**  
**WM-WOS-2SB**

Wood

**Texture:**  
Wood Oak

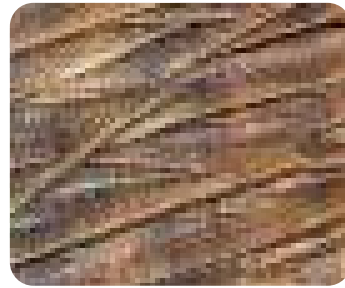

400 x 200 x 25 mm

Boards are boiled in linseed oil - this antiseptic protects the board from moisture and fungus, and also prevents the board from drying out. The boards are hand washed with water with the use of non-aggressive types of cleaner that are also used for washing dishes.

*\*After washing, wipe with a dry cloth and put vertically to dry at a natural temperature.*



**STUMP (2ND SIDE)**  
**WM-WOS-2SB**

Wood

**Texture:**  
Wood Oak



400 x 200 x 25 mm



# F O O D & B E V E R A G

DINNER/ DESSERT MENU FOLDER

BEVERAGE MENU FOLDER

BILL FOLDER

# MENU FOLDER



Menu Folder

3



# CUSTOMIZED MENU

## Ossiano Menu Design

Blue leatherette with logo engraving

Check Presenter



A La Carte

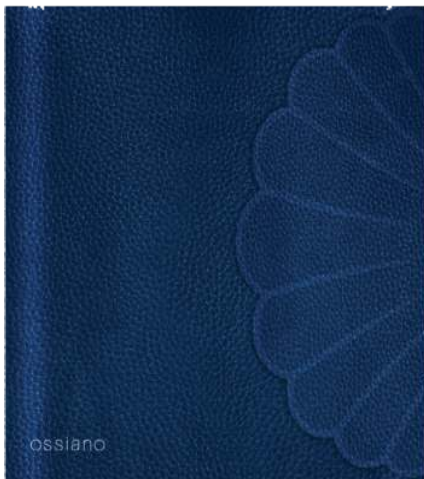

Wine List





# CUSTOMIZED MENU

## Hakkasan Menu Design

Dark brown genuine leather with logo engraving

A La Carte & Dessert Menu

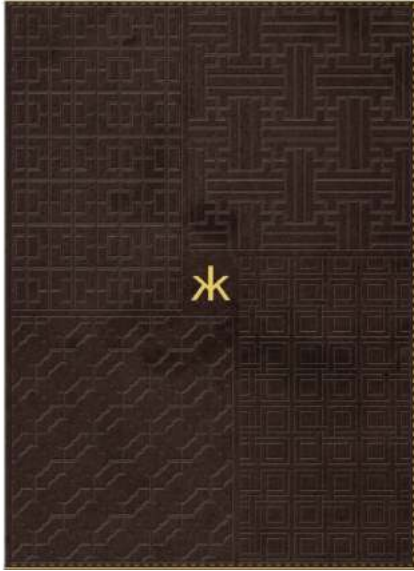

brown leather  
debossed brand pattern on cover  
with color matched edge

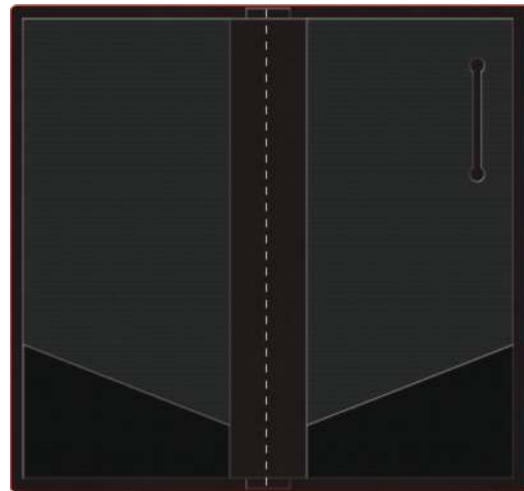

Check Presenter



Wine List

# CUSTOMIZED MENU

NOBU DUBAI MENU

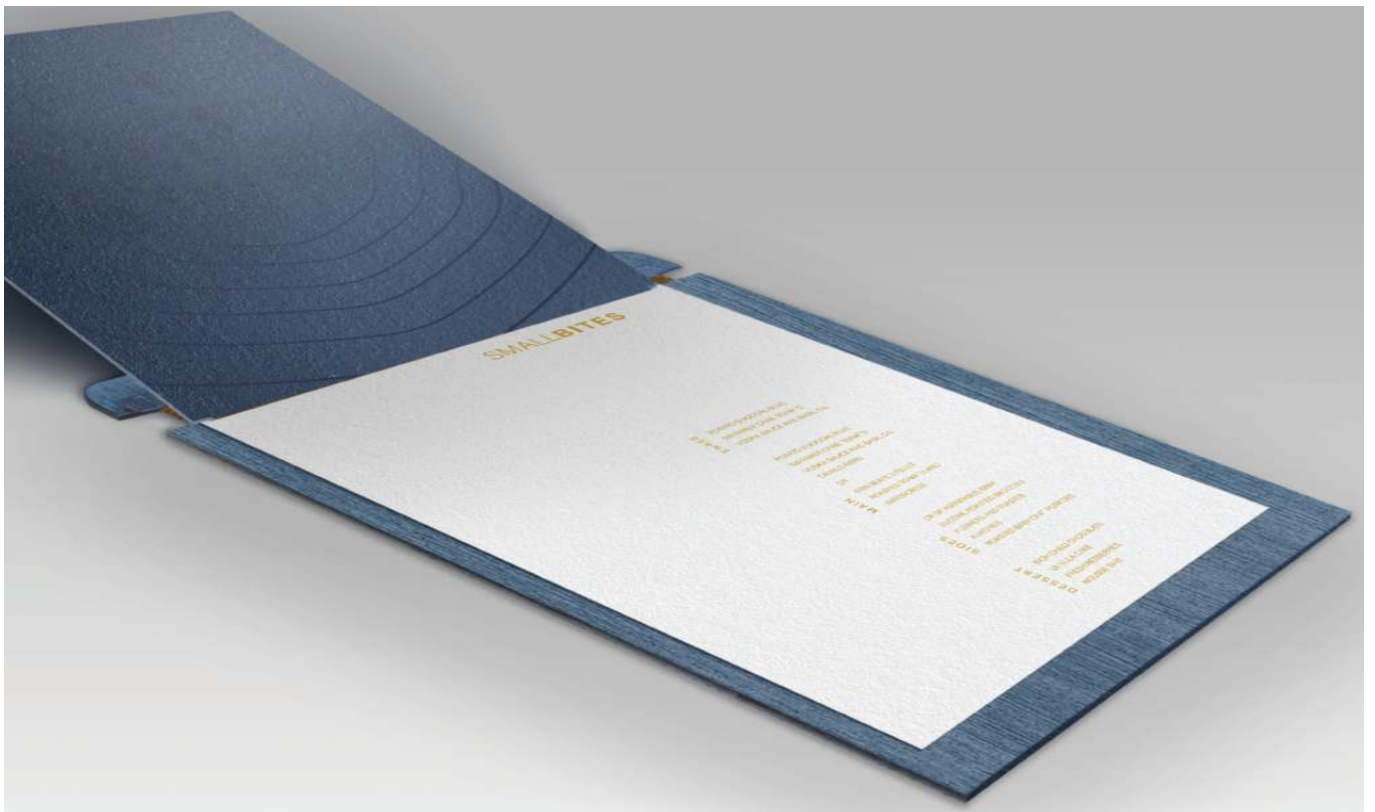

Beverage List

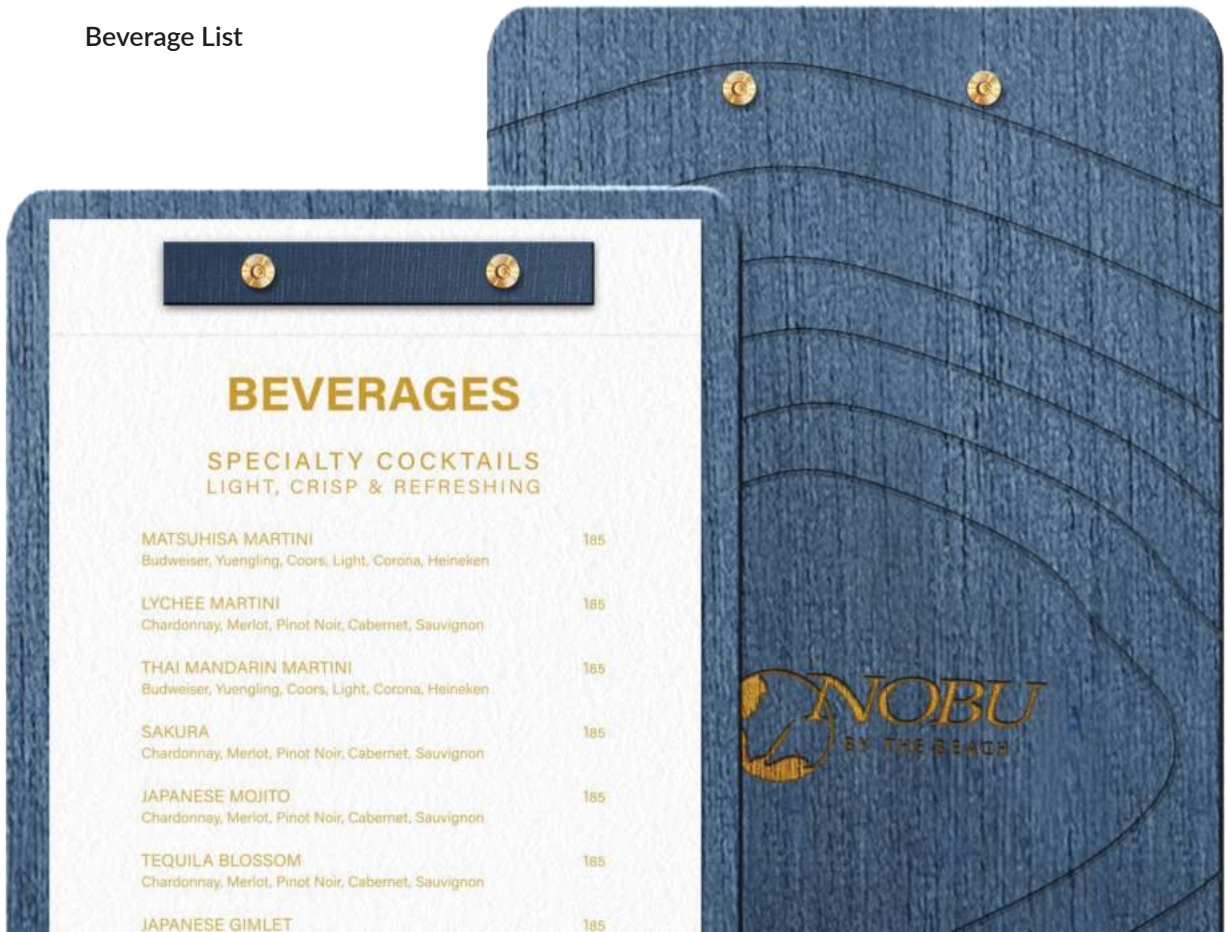

Check Presenter





I N R O O M  
G U E S T S U P P L I E S

BATHROOM

RECYCLE BINS

NOTEPAD HOLDER & TV

LEATHER SWATCHES



S



# BATHROOM

- Bath Salt Jar
- Cotton Bud Box
- Soap Dish
- Soap Dispenser
- Tissue Box



White Marble Collection  
WM-IN-M01

RESIN



MERCURY Collection  
WM-IN-M02

RESIN

# BATHROOM



Pluto Collection

**WM-IN-M03**

Leatherette

# BATHROOM

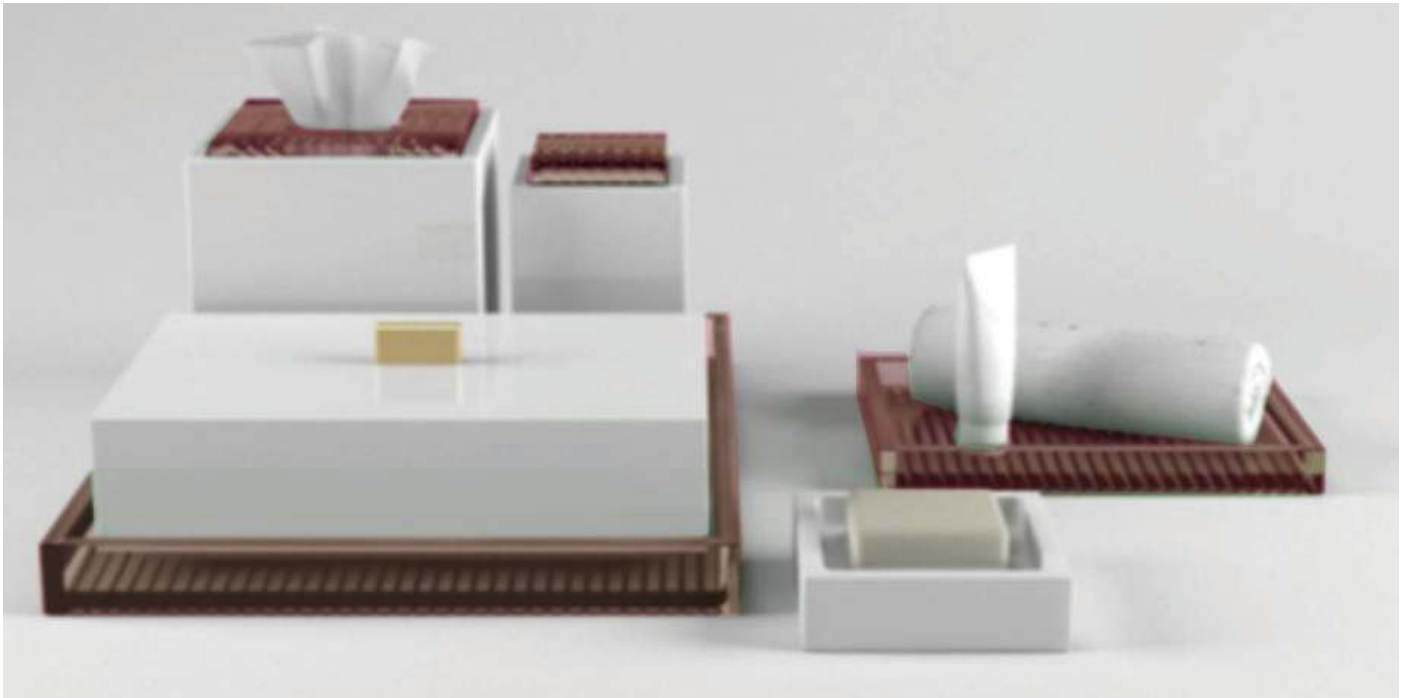

Saturn Collection  
WM-IN-S01  
RESIN



URANUS Collection  
WM-IN-U01  
RESIN



# BATHROOM



NEPTUNE Collection  
WM-IN-N01  
RESIN



JUPITER Collection  
WM-IN-J01  
RESIN



ARTEMIS Collection  
WM-IN-A01  
RESIN & WOOD



ARTEMIS Collection  
WM-IN-A02  
RESIN



ARTEMIS Collection  
WM-IN-A03  
RESIN

# BATHROOM



**GALAXY Collection**  
**WM-IN-G 01**  
RESIN

**EARTH Collection**  
**WM-IN-E01**  
RESIN & WOOD



Tissue Box 13x13x14cm  
Cotton Pad Container  
10x7x11cm  
Soap Dish 10x10x2.5cm  
Soap Dispenser 5x5x14.5cm  
Amenity Tray 42x20x5cm

# BATHROOM



**ECLIPSE Collection**  
**WM-IN-E01**

RESIN



**HALO Collection**  
**WM-IN-H01**

RESIN



Tissuebox  
with magnetic cover  
Size: L 141 x W 141 x H 145 mm

Soapdish  
Size:  
L 90 x W 90 x H 15 mm

Amenity Tray  
L 300 x W 102 x H 15 mm  
L 200 x W 102 x H 15 mm

Amenity Tray  
with Soapdish insert  
L 300 x W 90 x H 20 mm

matt white acrylic  
with transparant raisers underneath



**ANGEL Collection**  
**WM-IN-AN1**

RESIN

# BINS



**Bin round paper  
WM-IN-326**

Big round paper bin  
ø 220 m x 315 mm



**Bin round paper  
WM-IN-326**

Big round paper bin  
ø 220 m x 315 mm



**Bin round metal  
WM-IN-3266**

Round paper bin, metal inside  
covered in leather, non-slip base.  
ø 220 m x 315 mm



**Bin  
WM-IN-310**  
Large Paper Bin  
250x250xh 305 mm



**Bin  
WM-IN-1575**  
Small Paper Bin  
200 x 200 x 250mm

Square paper bins made in wood  
covered outside in leather, non slip base.

Fliptop bin  
Stainless steel, swing top  
Size: Ø 207 x H 300 mm,  
Capacity: ± 8 ltrs



**Bin  
WM-IN-89240**  
Bin with ring  
Brushed aluminium  
Capacity: ± 5 ltrs  
Size: Ø 180 x H 240 mm





# BINS



**Bin**  
WM-IN-89240

Square litter bin  
Including 2 metal innerliners  
Capacity: ± 12 ltrs.  
Size: L 180/230 x W 180/230 x H 300 mm



**Square litter bin**  
With black powdercoated metal innerliner  
Capacity: ± 12 ltrs.  
Size: L 180/230 x W 180/230 x H 300 mm

**Green innerliner**  
for organic waste  
Size: L 200 x W 100 x H 150 mm



**Round separation bin**  
With 2 metal innerliners  
Capacity: 2 x ± 5 ltrs.  
Size: Ø 235 x H 285 mm



**Separation bin**  
Black powder coated steel  
3 colored, removable innerliners  
Capacity: 3l/ innerliner, 12l in total  
Size: Ø 255 x H 305 mm



**Separation bin**  
2 colored,  
removable innerliners



# TISSUE BOX



## TISSUE BOXES

Tissue box in soft leatherette.  
Suitable to any international size on client request.

## TISSUE BOX SIZES

### EUROPE

square 10,1x11,0x h 11,5 cm  
rectangular 11,5x23x h 6,5 cm

### US

square 11,4x11,4x h 13,3 cm  
rectangular 19,8x10,8x h 13,2 cm



**Tissue Box  
Leatherette**

Including magnetic side-flap  
L 135 x W 135 x H 140 mm



**Tissue Box  
Leatherette**

Including magnetic side-flap  
L 250 x W 135 x H 85 mm

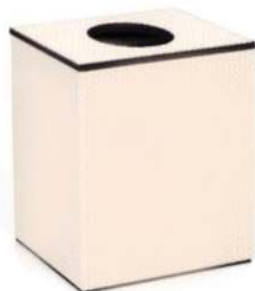

**Tissue Box  
Leatherette**

Including magnetic side-flap  
L 122 x W 107 x H 125 mm

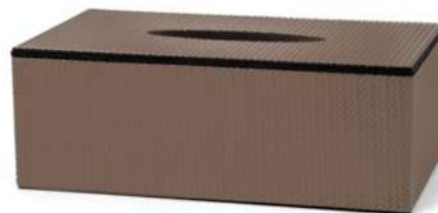

**Tissue Box  
Leatherette**

Including magnetic side-flap  
L 240 x W 120 x H 75 mm

# NOTEPAD & TV REMOTE HOLDER



**Notepad Holder**  
To fit A6 noteblock  
Size: L 160 x W 170 mm



**Guest Directory**  
Size: L 250 x W 350 x H 40 mm  
(closed)



**Remote Control Holder**  
Size: L 80 x W 130 x H 40 mm



**Remote Control Holder**  
Size: L 120 x W 45 x H 245 mm  
(closed)



**Remote Control Holder**  
Size: L 120 x W 45 x H 245 mm  
(closed)



**BROCHURE STAND**  
 Size: L 350 x W 120 x H 240 mm



**BLOTTER**  
 PU leather  
 Size: L 380 x W 380 x H 5 mm



**BLOTTER**  
 PU leather  
 Size: L 470 x W 370 mm



**With flap**  
 To fit A6 noteblock  
 Size: L 180 x W 210 x H 20 mm



**With flap**  
 To fit A6 noteblock  
 Size: L 180 x W 210 x H 20 mm



**BLOTTER**  
 Size: L 380 x W 380 x H 5 mm



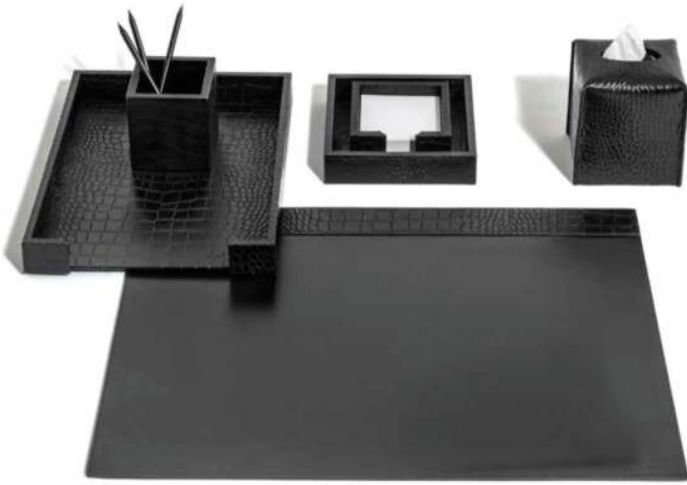

Desk set made in leather or wood covered with leather.

- 1. Letter tray, wood covered in leather.
- 2. Flexible desk pad, in leather, with upper band, non slip base.
- 3. Square tissue box in soft leather.
- 4. Pencil holder, small, wood covered in leather.
- 5. Paper holder, wood covered with leather,
- 6. Square pencile cup, wood covered with leather.
- 7. Notepad holder in leather metal zip with chrome finishing, pencil and lined pad included.

- 1. Letter tray in wood and leather,
- 2. Flexible desk pad, in leather, non slip base.
- 3. Pencil holder, small, wood covered in leather.
- 4. Paper holder, wood covered with leather,
- 5. Mouse pad, in leather, non-slip base.



## WELCOME TRAYS & KETTLE TRAYS



**Welcome Tray with Drawer**  
with 3 compartments  
EVA capsule insert for 6 capsules  
L 330 x W 400 x H 75 mm



**Nespresso Tray with Drawer**  
 with 3 compartments  
 EVA capsule insert for 6 capsules  
 Size: L 330 x W 400 x H 75 mm



**Welcome Tray Nespresso**  
 2 holes and raisers underneath for cable  
 Size: L 500 x W 400 x H 40 mm

## MINI BAR



**Stationary Box**  
 Dragon lining inside  
 5 compartments  
 Size: L 400 x W 250 x H 55 mm



61500-PB009

**Minibar Tray**  
 Size: L 350 x W 350 x H 30 mm

# ICE BUCKETS



**ICE BUCKET**  
Stainless steel inside  
Leatherette outside  
Size: Ø 140 x H 180 mm





# ICE BUCKETS



**Ice Bucket**  
Stainless steel inside  
Size: Ø 140 x H 180 mm



**Ice Bucket**  
Stainless steel inside  
Size: Ø 140 x H 180 mm

# MINI BAR TRAYS



MINIBAR TRAY



# MINI BAR

Customizable sets

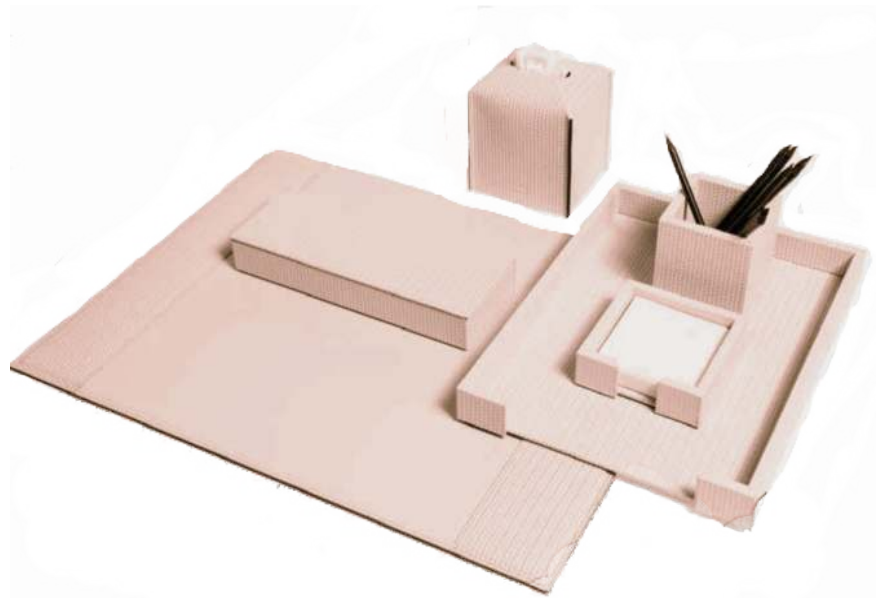

# WARDROBE ACCESSORIES

156

I N R O O M



**Turndown Tray**  
Size: L 350 x W 350 x H 30 mm



**Laundry organizer**  
Coat Brush  
Shoe horn



**Jewellery Box**  
Velvet inside  
Size: L 100 x W 260 x H 40 mm



**Jewellery Box**  
Velvet inside with mirror



# THE ESSENTIALS

## FINISHES

### OPTIONS



WM 1991



WM 1994

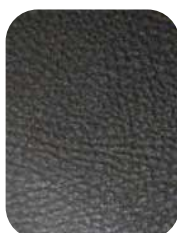

WM 1995



WM 1990



WM 1980

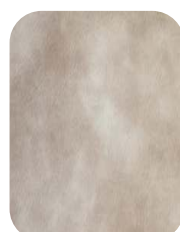

WM 1975



WM 1976



WM 1977



WM 1999



WM 2000



WM 2001



WM 2002



WM 2003



WM 2004



WM 2005

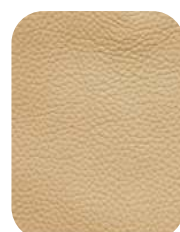

WM 2008



WM 2009

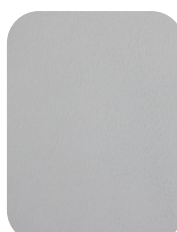

WM 2090



WM 2091

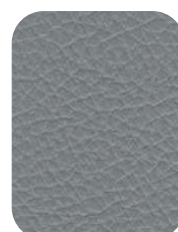

WM 2092



WM 2093



WM 2094



WM 2095



WM 2096

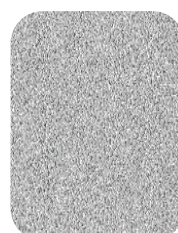

WM 2097

I N R O O M  
G U E S T S U P P L I E S

MIRRORS

KETTLES

LUGGAGE RACK

HAIR DRYER

SCALE

IRON & IRON BOARD

# MIRRORS



**TABLE MIRROR  
WM-IN-MI01**

RESIN

Cosmetic table mirror  
Solid brass-chrome finish  
3x magnification  
Size: L 115 x W 115 x H 300 mm



**TABLE MIRROR  
WM-IN-MI02**

RESIN

Cosmetic table mirror  
Solid brass-matt black finish  
3x magnification  
Size: W 150 x Ø 200 x H 350 mm



**SINGLE SIDED  
WM-ES21DQRT**

RESIN

Diameter: 213 mm  
Height 385mm



**DOUBLE SIDED  
WM-IN-MI01**

RESIN

Diameter: 210mm  
Height 420mm

# DOUBLE SIDED TOUCH MIRROR

Face Detection LED MIRROR

Color Option  
Black & Chrome



Sensor Mirror  
WM-PD24FT



Sensor Mirror  
WM-PS22T3R



Sensor Mirror  
WM-ES21SQU



# SINGLE SIDED



**SINGLE SIDED  
WM-ES21DQRT**

Diameter: 213 mm  
Height 385mm

**SINGLE SIDED  
WM-ES22ST3**

Diameter: 213 mm  
Height 385mm

**SINGLE SIDED  
WM-ES21ST3R**

Diameter: 210 mm  
Height 380 mm

# BATHROOM BINS

Pedal bin  
Metal bin with plastic innerliner  
Softclose, fingerprint proof  
Capacity: ± 6 ltrs.  
Size L 210 x W 250 x H 285 mm



**Pedal bin**

Metal bin with plastic innerliner  
Softclose, fingerprint proof  
Capacity: ± 6 ltrs.  
L 210 x W 250 x H 285 mm

# KETTLE



**Kettle Gooseneck  
WM-KT201**

0.8L Stainless Steel Wattage: 1200W 0.8 Liters  
Electric Gooseneck Quick Boil Electric Kettle with  
360 Degree Swivel Base.  
Safety Protection: NTC Temperature Sensor, Auto-  
matic Power-off, Boil-dry Safety Feature,  
Leak-proof Design. Wattage: 1200W



**Kettle  
WM-KT204**

Electrical Kettle  
Capacity: 0.8L  
Power: 1000W, 220V, 50HZ  
Material: stainless steel  
304 + AB



**Kettle**

**WM-KT230**

Electrical Kettle  
Capacity: 1.0L  
Power: 1000W, 220V, 50HZ  
Material: stainless steel 304 + color steel shell



**Kettle**

**WM-KT220**

Capacity: 0.8L  
Voltage: 220V-240V  
Wattage: 800W  
Material: food-grade 304 stainless steel  
+ plastic shell with automatic power-off  
safety protection.



**Kettle**

**WM-KT301**

Electrical Kettle  
Capacity: 0.8L  
Power: 1000W, 220V, 50HZ  
Material: stainless steel 304 + ABS



**Kettle**

**WM-KT229**

Electrical Kettle  
Capacity: 0.8L  
Power: 1000W, 220V, 50HZ  
Material: stainless steel 304 + ABS

# LUGGAGE RACK



**GOLD FOLDABLE RACK**  
**WM-IN-1326**

stainless steel in gold coat,  
black color belt with back  
Size:L610x470x670



# HAIR DRYER



**Hair Dryer**  
**WM-IN-2389**  
**2100 W**

**Power: 220V, 50Hz,**  
Color: Black.

- 1. Over heat protection
- 2. With Loop
- 3. Rubber Cable
- 4. Homothermal
- 5. With Concentrator
- 6. Cord Length: 1.8M



**Hair Dryer**  
**WM-IN-2201**  
**2200 W**

**Power: 220V, 50Hz,**  
Color: Black.

- 1. Over heat protection
- 2. With Loop
- 3. Rubber Cable
- 4. Homothermal
- 5. With Concentrator
- 6. Cord Length: 1.8M



**Hair Dryer**  
**WM-IN-2320**  
**1800 W**

**Power: 220V, 50Hz,**  
HAIR DRYER 1800 WATT  
Ultra-light hairdryer 1800w  
Security thermal cutoff  
6 air flow/temperature combinations  
Cool air button  
Concentrator nozzle  
Removable filter



**Foldable Hair Dryer**  
**WM-KT126**  
**1600 W**

**Power: 220V, 50Hz,**



**Foldable Hair Dryer**  
**WM-KT125**  
**1600 W**

**Power: 220V, 50Hz,**



# SCALE



**ELECTRONIC BATHROOM SCALE**

**WM-?**



**280\*280\*25mm**

Color: Black.  
LED display with easy-to-read white digits.  
Temper glass thickness 5mm.  
Step-on technology  
Overload and battery level indicator, auto-  
matic switch-off



**ELECTRONIC BATHROOM SCALE**

**WM-?**



**300\*300\*20cm**

Color: Black.  
LED display with easy-to-read white digits.  
Temper glass thickness 8mm.  
Step-on technology  
Overload and battery level indicator, auto-  
matic switch-off



**ELECTRONIC BATHROOM SCALE**

**WM-BE1722**



**300x300x18mm**

Transparent lightness – noble black and  
white with a glass weighing surface



**ELECTRONIC BATHROOM SCALE**

**WM-BE1906**



**333 x 303 x 23mm**

Elegant and precise – glass scales with BMI  
calculation, automatic power-off



**ELECTRONIC BATHROOM SCALE**

**WM-BE2107**



**310\*300mm**

Genuine Bamboo  
High-precision strain  
gauge sensor system  
rubberised feet



**ELECTRONIC BATHROOM SCALE**

**WM-BE1513**



**300x300x16 mm**

Classy – attractive bathroom scale  
with elegant silver surface and  
a weighing capacity of  
180 kg automatic power-off

# IRON & IRON BOARD



## IRON, STEAM & DRY

1800 watt (220-240 volt / 50 Hz)  
safe auto shut-off after 30 seconds when unused  
and horizontal (within 8 minutes when vertical)  
anti-theft: 2.5 meter cable  
non-stick soleplate



## STEAM IRON

220-240V 50/60Hz , 1800W  
Adjustable Temperature for different fabrics;  
Dry/Spray/Steam/Burst steam/Self-cleaning  
Anti-calc/Anti-drip/Auto shut-off  
\*Water tank capacity: 320ML  
\*Dial thermostat control; \*Temperature pilot  
light; \*Soft handle  
\*Soleplate: Ceramic

## IRON & IRON BOARD



### **IRONBOARD**

(removable iron holder)  
with cover

Anthracite,  
Adjustable in height,  
Fire-resistant metalized cover  
Size: L 110 x W 34 x H 73 cm  
Size folded: W 36 x H 123cm



### **IRONBOARD**

(fixed iron holder)  
with cover

Anthracite,  
Adjustable in height,  
Fire-resistant metalized cover  
Size: L 110 x W 34 x H 73 cm  
Size folded: W 36 x H 123cm

# OUR CLIENTS

<b>ACCOR</b>			
Fairmont Business Gate, Riyadh	Riyadh, KSA		
Fairmont Fujairah Beach Resort	Dubai, UAE		
Fairmont Hotel & Serviced Restaurants	Dubai, UAE		
Fairmont The Palm	Fujairah, UAE		
Ibis DWTC	Dubai, UAE		
Jumeirah Beach Hotel	Dubai, UAE		
M Gallery Doha Qatar	Doha, Qatar		
Mövenpick Bahrain	Manama, Bahrain		
Mövenpick Dubai Media City	Dubai, UAE		
Mövenpick Hotel Jumeirah Beach	Dubai, UAE		
Novotel World Trade Center	Dubai, UAE		
Sheraton Dubai-Mall of the Emirates	Dubai, UAE		
Sofitel Bahrain	Manama, Bahrain		
Sofitel Dubai Jumeirah Beach	Dubai, UAE		
Swissotel Al Ghurair	Dubai, UAE		
<b>EMAAR</b>			
Al Manzil Hotel	Dubai, UAE		
Arabian Ranches	Dubai, UAE		
Atmosphere Burj Khalifa	Dubai, UAE		
Dubai Marina Yacht Club	Dubai, UAE		
The Address Boulevard Dubai	Dubai, UAE		
The Address Downtown Dubai	Dubai, UAE		
The Address Dubai Mall	Dubai, UAE		
The Address Fountain View Hotel	Dubai, UAE		
The Address Montgomerie	Dubai, UAE		
The Dubai Opera House	Dubai, UAE		
The Palace Downtown	Dubai, UAE		
Vida Hotels & Residences	Dubai, UAE		
<b>FOUR SEASONS</b>			
Four Seasons DIFC	Dubai, UAE		
Four Seasons, Doha	Doha, Qatar		
Four Seasons, Kuwait	Kuwait City, Kuwait		
<b>HILTON</b>			
Hilton Dubai Creek	Dubai, UAE		
Waldorf Astoria (DIFC)	Dubai, UAE		
Waldorf Astoria Kuwait	Kuwait City, Kuwait		
<b>HYATT</b>			
Grand Hyatt Doha	Doha, Qatar		
Hyatt Regency Dubai Creek	Dubai, UAE		
Park Hyatt Abu Dhabi Hotel & Villas	Abu Dhabi, UAE		
Park Hyatt Zanzibar	Zanzibar, Tanzania		
<b>IHG</b>			
Crowne Plaza AUH	Abu Dhabi, UAE		
Crowne Plaza West Bay	Doha, Qatar		
Indigo Hotel	Dubai, UAE		
InterContinental Dhaka	Dhaka, Bangladesh		
InterContinental Doha	Doha, Qatar		
InterContinental Dubai Marina	Dubai, UAE		
<b>JUMEIRAH</b>			
Burj Al Arab	Dubai, UAE		
Jumeirah Al Wathba Desert Resort & Spa	Abu Dhabi, UAE		
Jumeirah at Saadiyat Islands	Abu Dhabi, UAE		
Jumeirah Beach Hotel	Dubai, UAE		
Jumeirah Golf Estates	Dubai, UAE		
Jumeirah Hotel at Etihad Towers	Abu Dhabi, UAE		
Jumeirah Restaurants - Duck Hook	Dubai, UAE		
Jumeirah Zabeel Saray	Dubai, UAE		
Madinat Jumeirah Al Naseem	Dubai, UAE		
Madinat Jumeirah Al Qasr	Dubai, UAE		
Madinat Jumeirah Al Samar Lounge	Dubai, UAE		
Madinat Jumeirah Mina A Salam	Dubai, UAE		
Madinat Jumeirah Mina A Salam-Bahri Bar	Dubai, UAE		
Madinat Jumeirah Phase 4	Dubai, UAE		
Madinat Jumeirah Souk	Dubai, UAE		
Madinat Jumeirah-Jan Ambar	Dubai, UAE		
Noodle House-Madinat Jumeirah	Dubai, UAE		
The Noodle House Dubai Mall	Dubai, UAE		
<b>KEMPINSKI</b>			
Kempinski Emerald Palace, The Palm	Dubai, UAE		
Kempinski The Pearl Doha - Tora Tora Restaurant	Doha, Qatar		
<b>KERZNER</b>			
Atlantis The Palm	Dubai, UAE		
One & Only the Palm	Dubai, UAE		
One Central Offices Dubai	Dubai, UAE		
<b>MARRIOTT INTERNATIONAL</b>			
Ajman Saray Resort	Ajman, UAE		
Al Habtoor City - W Hotel	Dubai, UAE		
Al Habtoor Polo Club	Dubai, UAE		
Aloft Hotel DCC	Dubai, UAE		
Aloft Palm Jumeirah	Dubai, UAE		
Courtyard Al Barsha Dubai	Dubai, UAE		
Courtyard Al Barsha Dubai	Dubai, UAE		
Courtyard by Marriott WTC AUH	Abu Dhabi, UAE		
JW Marriott Marquis Dubai	Dubai, UAE		
Lapita Hotel, Autograph Collection	Dubai, UAE		
Le Meridien Abu Dhabi	Abu Dhabi, UAE		
Le Meridien Dubai Hotel & Conference	Dubai, UAE		
Le Meridien Mina Seyahi	Dubai, UAE		
Marriott Courtyard Riyadh	Riyadh, KSA		
Marriott Ikeja	Lagos, Nigeria		
Park Regis Business Bay	Dubai, UAE		
Renaissance Hotel Dubai	Dubai, UAE		
Sheraton Abu Dhabi	Abu Dhabi, UAE		
Sheraton Dubai Creek Hotel & Towers	Dubai, UAE		
Sheraton Grand Hotel Dubai	Dubai, UAE		
Smart Hotels	Dubai, UAE		
St. Regis Saadiyat Island AUH	Abu Dhabi, UAE		
The Ritz-Carlton DIFC	Dubai, UAE		
The Ritz-Carlton JBR, Dubai	Dubai, UAE		
The Ritz-Carlton, AUH	Abu Dhabi, UAE		





2

0

2

2



Warehouse 19, Al Quoz  
Industrial Area 3, Off Sheikh  
Zayed Road, P.O. Box 283073,  
Dubai, UAE

Phone: +971 4 224 7373  
Email: [info@wildmagma.com](mailto:info@wildmagma.com)  
[www.wildmagma.com](http://www.wildmagma.com)